

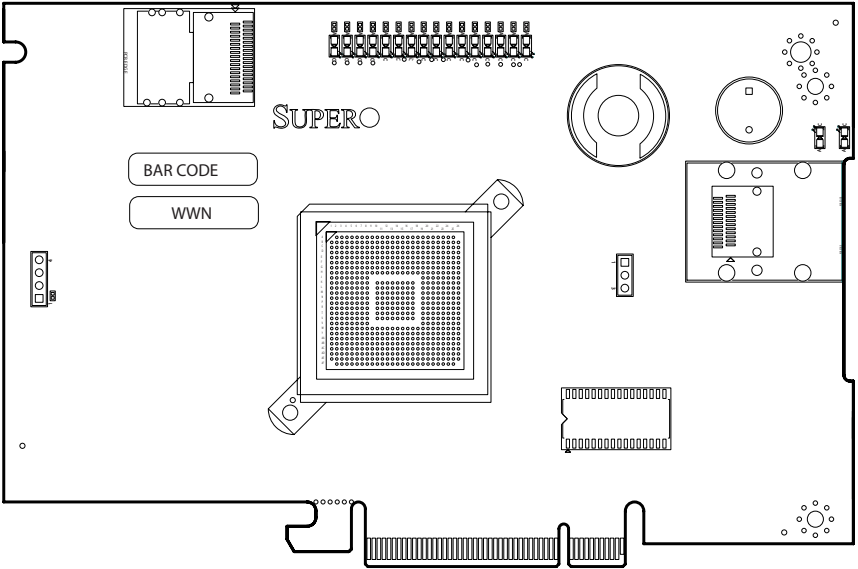

AOC-USAS-L4i/L4iR Add-On Card



User's Manual

Revision 1.0c

The information in this User's Manual has been carefully reviewed and is believed to be accurate. The vendor assumes no responsibility for any inaccuracies that may be contained in this document, makes no commitment to update or to keep current the information in this manual, or to notify any person or organization of the updates. **Please Note: For the most up-to-date version of this manual, please see our web site at www.supermicro.com.**

Super Micro Computer, Inc. ("Supermicro") reserves the right to make changes to the product described in this manual at any time and without notice. This product, including software, if any, and documentation may not, in whole or in part, be copied, photocopied, reproduced, translated or reduced to any medium or machine without prior written consent.

IN NO EVENT WILL SUPERMICRO BE LIABLE FOR DIRECT, INDIRECT, SPECIAL, INCIDENTAL, SPECULATIVE OR CONSEQUENTIAL DAMAGES ARISING FROM THE USE OR INABILITY TO USE THIS PRODUCT OR DOCUMENTATION, EVEN IF ADVISED OF THE POSSIBILITY OF SUCH DAMAGES. IN PARTICULAR, SUPERMICRO SHALL NOT HAVE LIABILITY FOR ANY HARDWARE, SOFTWARE, OR DATA STORED OR USED WITH THE PRODUCT, INCLUDING THE COSTS OF REPAIRING, REPLACING, INTEGRATING, INSTALLING OR RECOVERING SUCH HARDWARE, SOFTWARE, OR DATA.

Any disputes arising between manufacturer and customer shall be governed by the laws of Santa Clara County in the State of California, USA. The State of California, County of Santa Clara shall be the exclusive venue for the resolution of any such disputes. Super Micro's total liability for all claims will not exceed the price paid for the hardware product.

FCC Statement: This equipment has been tested and found to comply with the limits for a Class A digital device pursuant to Part 15 of the FCC Rules. These limits are designed to provide reasonable protection against harmful interference when the equipment is operated in a commercial environment. This equipment generates, uses, and can radiate radio frequency energy and, if not installed and used in accordance with the manufacturer's instruction manual, may cause harmful interference with radio communications. Operation of this equipment in a residential area is likely to cause harmful interference, in which case you will be required to correct the interference at your own expense.

California Best Management Practices Regulations for Perchlorate Materials: This Perchlorate warning applies only to products containing CR (Manganese Dioxide) Lithium coin cells. Perchlorate Material-special handling may apply. See www.dtsc.ca.gov/hazardouswaste/perchlorate for further details.



WARNING: HANDLING OF LEAD SOLDER MATERIALS USED IN THIS PRODUCT MAY EXPOSE YOU TO LEAD, A CHEMICAL KNOWN TO THE STATE OF CALIFORNIA TO CAUSE BIRTH DEFECTS AND OTHER REPRODUCTIVE HARM.

Manual Revision 1.0c

Release Date: June 24, 2009

Unless you request and receive written permission from Super Micro Computer, Inc., you may not copy any part of this document. Information in this document is subject to change without notice.

LSI, Integrated Mirroring, Integrated RAID, Integrated Striping, Fusion-MPT, and MegaRAID are trademarks or registered trademarks of LSI Corporation. Other products and companies referred to herein are trademarks or registered trademarks of their respective companies or mark holders.

Portions of this document © 2006-2007 LSI Corporation

Copyright © 2009 by Super Micro Computer, Inc.
All rights reserved.

Printed in the United States of America

Table of Contents

Chapter 1 Safety Guidelines	1-1
1-1 ESD Safety Guidelines	1-1
1-2 General Safety Guidelines	1-1
1-3 An Important Note to Users	1-1
Chapter 2 Connectors, Jumpers and Indicators	2-1
2-1 Front Connectors and Pin Definitions	2-1
Internal SAS Connectors	2-2
Active LED Connector	2-2
2-2 Front Jumper Locations and Pin Definitions	2-3
2-3 LED Indicators	2-4
2-4 RAID Minimum Drive Requirements	2-5
Chapter 3 RAID Modes, Firmware and Drivers	3-1
3-1 RAID Modes	3-1
3-2 Getting Firmware Downloads	3-2
3-3 Flashing Firmware	3-2
3-4 Downloading RAID Mode Drivers	3-2
3-5 Activating RAID Modes in OPRM BIOS	3-3
Chapter 4 MegaRAID BIOS Configuration Utility	4-1
4-1 Performing a Quick Configuration	4-1
4-2 Configuring Arrays and Logical Drives	4-1
Starting the MegaRAID BIOS CU	4-2
Using Easy Configuration	4-2
Using New Configuration and View/Add Configuration	4-4
Creating a Global Hotspare Drive	4-6
Initializing Virtual Drives	4-6
First Initialization Method	4-7
Second Initialization Method	4-7
4-3 Setting the Hard Disk Write Cache and Read Ahead Policies	4-8
4-4 Rebuilding a Drive	4-9
4-5 Hot Plug Support	4-10
4-6 Checking Data Consistency	4-11
4-7 Viewing and Changing Device Properties	4-12

- Viewing and Changing Adapter Properties 4-12
- Viewing and Changing Virtual Drive Properties 4-13
- Viewing Physical Drive Properties 4-13
- 4-8 Forcing Drives Online or Offline..... 4-13
- 4-9 Configuring a Bootable Virtual Drive 4-14
- 4-10 Deleting a Virtual Drive 4-14
- 4-11 Clearing a Storage Configuration 4-14
- Chapter 5 MegaRAID Overview and Installation 5-1**
 - 5-1 Overview 5-1
 - Creating Storage Configurations..... 5-1
 - 5-2 Hardware and Software Requirements..... 5-2
 - 5-3 Installing for Windows..... 5-2
 - 5-4 Installing for Linux 5-5
 - Linux Error Messages 5-5
- Chapter 6 MegaRAID Window and Menus 6-1**
 - 6-1 Starting MegaRAID Storage Manager Software..... 6-1
 - 6-2 MegaRAID Storage Manager Window 6-4
 - Physical/Logical View Panel 6-4
 - Properties/Operations/Graphical View Panel..... 6-5
 - Event Log Panel..... 6-5
 - Menu Bar 6-5
 - File Menu 6-6
 - Operations Menu..... 6-6
 - Group Operations Menu..... 6-6
 - Log Menu 6-6
 - Help Menu..... 6-6
 - 6-3 Creating a New Storage Configuration 6-6
 - Understanding Virtual Disk Parameters 6-8
 - Using Auto Configuration 6-8
 - Using Guided Configuration..... 6-10
 - Using Manual Configuration: RAID 0 6-13
 - Using Manual Configuration: RAID 1 6-15
 - Using Manual Configuration: RAID 5 6-16
 - Using Manual Configuration: RAID 10 6-17
 - 6-4 Adding or Deleting a Hotspare Disks 6-18
 - 6-5 Changing Adjustable Task Rates..... 6-19
 - 6-6 Changing Virtual Disk Properties..... 6-20

6-7 Deleting a Virtual Disk	6-20
6-8 Saving a Storage Configuration to Disk.....	6-21
6-9 Clearing a Storage Configuration from a Controller	6-21
6-10 Adding a Saved Storage Configuration	6-22
Chapter 7 Integrated Mirroring and Integrated Mirroring Enhanced	7-1
7-1 Introduction.....	7-1
7-2 IM and IME Features	7-2
7-3 IM/IME Description.....	7-2
7-4 Integrated RAID Firmware	7-4
Resynchronization with Concurrent Host I/O Operation	7-4
Metadata Support.....	7-4
Hot Swapping.....	7-4
SMART Support.....	7-5
Hot Spare Disk	7-5
Media Verification.....	7-5
Disk Write Caching	7-5
NVS RAM Usage	7-5
7-5 Fusion-MPT Support.....	7-6
7-6 IM/IME Configuration Overview	7-6
7-7 Creating IM and IME Volumes	7-6
Creating an IM Volume	7-7
Creating an IME Volume	7-11
Creating a Second IM or IME Volume.....	7-11
7-8 Managing Hot Spares	7-12
7-9 Other Configuration Tasks	7-13
Viewing Volume Properties	7-13
Synchronizing an Array.....	7-13
Activating an Array.....	7-14
Deleting an Array	7-14
Locating Drives in a Volume	7-15
Selecting a Boot Disk.....	7-15
Chapter 8 Integrated Striping	8-1
8-1 Introduction.....	8-1
8-2 IS Features.....	8-1
8-3 IS Description.....	8-2

- 8-4 Integrated Striping Firmware 8-3
 - Metadata Support..... 8-3
 - SMART Support..... 8-3
 - Disk Write Caching 8-3
- 8-5 Fusion-MPT Support..... 8-3
- 8-6 IS Configuration Overview 8-3
- 8-7 Creating IS Volumes 8-4
- 8-8 Creating a Second IS Volume 8-7
- 8-9 Other Configuration Tasks 8-7
 - Viewing IS Volume Properties..... 8-7
 - Activating an Array..... 8-7
 - Deleting an Array 8-8
 - Locating a Disk in a Volume..... 8-8
 - Selecting a Boot Disk..... 8-9

Chapter 9 Using the CFGGEN IR Configuration Utility .9-1

- 9-1 Hardware and Software Requirements..... 9-1
- 9-2 CFGGEN Interface Description..... 9-2
- 9-3 CFGGEN Commands..... 9-2
 - Common Command Line Parameters 9-3
 - CREATE Command 9-3
 - DEFAULTS Command 9-5
 - DISPLAY Command 9-5
 - FORMAT Command 9-8
 - HOTSPARE Command 9-9
 - STATUS Command..... 9-9
 - SETOFFLINE Command 9-10
 - SETONLINE Command 9-11
 - AUTO Command (EFI Version Only) 9-11
 - DISABLEIR Command (EFI Version Only) 9-13
 - ENABLEIR Command (EFI Version Only) 9-13
 - LIST Command (EFI Version Only) 9-14

Preface

About this Manual

This manual is written for system integrators, PC technicians and knowledgeable PC users who intend to integrate SuperMicro's AOC-USAS-L4i/L4iR add-on cards to their system.

Product Features

The AOC-USAS-L4i/L4iR add-on cards offer the following features:

- UIO Form Factor
- Internal and External "ipass" cable ports.
- Multiple LED Activity/Failure indicators.

In addition, the AOC-USAS-L4iR add-on card offers:

- IR Mode and SWR with iButton
- RAID 5 with iButton

Operating Systems Supported

The AOC-USAS-L4i/L4iR add-on cards supports the following Operating Systems (OS):

- Windows 2000/Windows XP/Windows 2003
- Red Hat Enterprise Linux/SUSE Linux

An Important Note to Users

All images and layouts shown in this user's guide are based upon the latest PCB Revision available at the time of publishing. The card you have received may or may not look exactly the same as the graphics shown in this manual.

Contacting SuperMicro

Headquarters

Address: Super Micro Computer, Inc.
980 Rock Ave.
San Jose, CA 95131 U.S.A.

Tel: +1 (408) 503-8000

Fax: +1 (408) 503-8008

Email: marketing@supermicro.com (General Information)
support@supermicro.com (Technical Support)

Web Site: www.supermicro.com

Europe

Address: Super Micro Computer B.V.
Het Sterrenbeeld 28, 5215 ML
's-Hertogenbosch, The Netherlands

Tel: +31 (0) 73-6400390

Fax: +31 (0) 73-6416525

Email: sales@supermicro.nl (General Information)
support@supermicro.nl (Technical Support)
rma@supermicro.nl (Customer Support)

9

Asia-Pacific

Address: Super Micro Computer, Inc.
4F, No. 232-1, Liancheng Rd.
Chung-Ho 235, Taipei County
Taiwan, R.O.C.

Tel: +886-(2) 8226-3990

Fax: +886-(2) 8226-3991

Web Site: www.supermicro.com.tw

Technical Support:

Email: support@supermicro.com.tw

Tel: +886-2-8228-1366, ext. 132 or 139

Chapter 1

Safety Guidelines

To avoid personal injury and property damage, carefully follow all the safety steps listed below when accessing your system or handling the components.

1-1 ESD Safety Guidelines

Electric Static Discharge (ESD) can damage electronic components. To prevent damage to your system, it is important to handle it very carefully. The following measures are generally sufficient to protect your equipment from ESD.

- Use a grounded wrist strap designed to prevent static discharge.
- Touch a grounded metal object before removing a component from the antistatic bag.
- Handle the add-on card by its edges only; do not touch its components, peripheral chips, memory modules or gold contacts.
- When handling chips or modules, avoid touching their pins.
- Put the card and peripherals back into their antistatic bags when not in use.

1-2 General Safety Guidelines

- Always disconnect power cables before installing or removing any components from the computer.
- Disconnect the power cable before installing or removing any cables from the system.
- Make sure that the add-on card is securely and properly installed on the motherboard to prevent damage to the system due to power shortage.

1-3 An Important Note to Users

All images and layouts shown in this user's guide are based upon the latest PCB Revision available at the time of publishing. The card you have received may or may not look exactly the same as the graphics shown in this manual.

Notes

Chapter 2

Connectors, Jumpers and Indicators

2-1 Front Connectors and Pin Definitions

Connectors are used to attach the AOC-USAS-L4i/L4IR add-on card to the system's mainboard.

Figure 2-1. AOC-USAS-L4i/L4IR Add On Cards Front Connectors and Jumpers

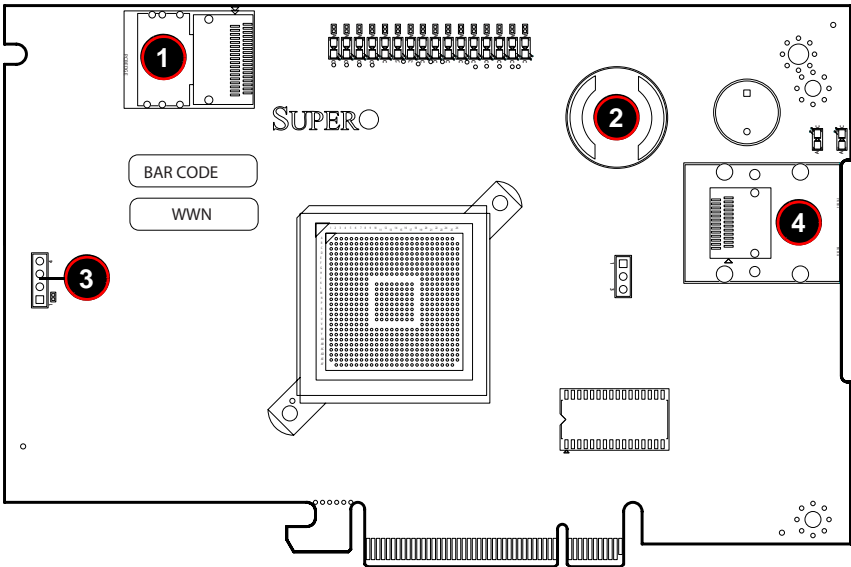

Table 2-1 lists the add-on card's front connectors.

Table 2-1. Front Connectors and Pin Definitions

Number	Description
1	Internal SAS Connector
2	I-Button
3	Front Panel LED Connector
4	External SAS Connector

Internal SAS Connectors

The Internal SAS port (J3) connects to the backplane allowing the motherboard to access the hard drives and RAID capabilities. This connector supports up to 4 HDD ports.

Use a single port SAS "ipass" cable (Super Micro order number CBL - 0108L-02) for connecting to the hard drives.

I-Button Socket

The I-Button is used to enable RAID 5 with the AOC-USAS-L4IR card only. To do this, you must install a SuperMicro I-button and enable the SWR5 jumper.

Active LED Connector

The LED connector allows the add-on card to display activity and status using a standard LED panel. [Table 2-2](#) lists the pin definitions for this connector.

Table 2-2. Front Jumpers and Pin Definitions (U-12)

Number	Description
1	A - LED+
2	A - LED-
3	B - LED+
4	B - LED-

External SAS Connector

The External SAS port (J4) allows the motherboard to connect to an external backplane. This connector supports up to 4 SAS drives.

Use a single port, external SAS cable (Super Micro order number CBL - 0166L) to connect to the backplane.

2-2 Front Jumper Locations and Pin Definitions

Figure 2-2. Jumper Locations

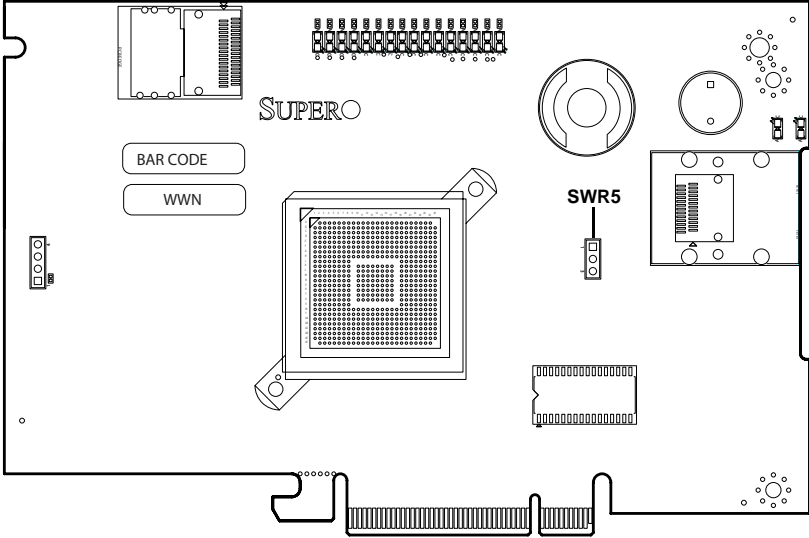

To modify the operation of the backplane, jumpers can be used to choose between optional settings. Jumpers create shorts between two pins to change the function of the connector. Pin 1 is identified with a square solder pad on the printed circuit board.

Figure 2-2 shows jumper locations for the add-on card, while Table 2-3 lists the add-on card's pin definitions.



NOTE: On two pin jumpers, "Closed" means the jumper is on and "Open" means the jumper is off the pins.

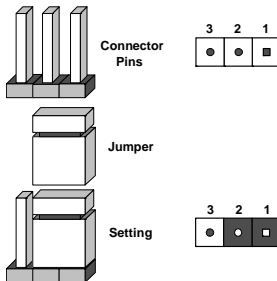

Table 2-3. SWR5 Jumper Settings

Jumper	Jumper Settings	Note
SWR5	1-2: Enabled 3: Disabled	Enables or Disables Software Raid 5 on the AOC-USAS-L4iR add-on card only. Leave disabled for the AOC-USAS-L4i add-on card.

2-3 LED Indicators

Figure 2-3. LED Indicators

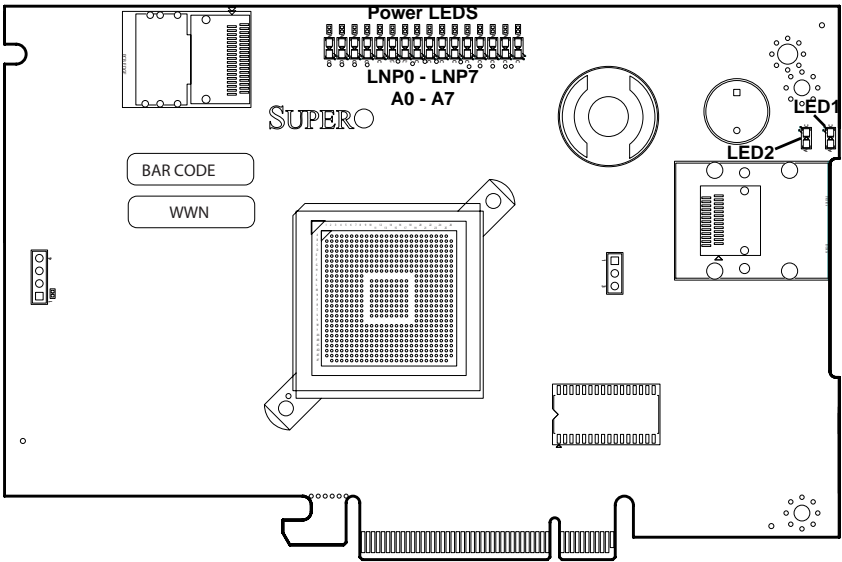

Figure displays LED indicators on the add-on card, while table lists the individual LEDs, their state and their specification.

Table 2-4. Front Pane LEDs

LED	State	Specification
LED1	Flashing	SAS Port Activity
LED2	Flashing	Heartbeat and Fault
LNP0	On	Fault in HDD #0
LNP1	On	Fault in HDD #1
LNP2	On	Fault in HDD #2
LNP3	On	Fault in HDD #3
LNP4	On	Fault in HDD #4

Table 2-4. Front Pane LEDs (Continued)

LED	State	Specification
LNP5	On	Fault in HDD #5
LNP6	On	Fault in HDD #6
LNP7	On	Fault in HDD #7
A0	Flashing	Normal Activity in HDD #0
A1	Flashing	Normal Activity in HDD #1
A2	Flashing	Normal Activity in HDD #2
A3	Flashing	Normal Activity in HDD #3
A4	Flashing	Normal Activity in HDD #4
A5	Flashing	Normal Activity in HDD #5
A6	Flashing	Normal Activity in HDD #6
A7	Flashing	Normal Activity in HDD #7

2-4 RAID Minimum Drive Requirements

Use [Table 2-5](#) to determine the minimum number of hard drives needed to set up a RAID environment in SR mode for the AOC-USAS-L4i/L4IR Add-on Card. Use [Table 2-6](#) to determine the minimum number of hard drives needed to set up a RAID environment in IR mode for the AOC-USAS-L4i/L4IR Add-on Card.

Table 2-5. RAID Minimum Drive Requirements for SR Mode

RAID	Minimum Hard Drives
RAID 0	2
RAID 1	2
RAID 5	3
RAID 10	4 (Two RAID 1 Arrays)

Table 2-6. RAID Minimum Drive Requirements for IR Mode

RAID	Minimum Hard Drives
RAID 0 (Integrated Striping)	2
RAID 1 (Integrated Mirroring)	2
RAID 1E (Integrated Mirroring Enhanced)	3

Notes

Chapter 3

RAID Modes, Firmware and Drivers

To change RAID modes from the AOC-USAS-L4i/L4IR Add-on Card's default IT Mode, you need to flash your system's BIOS with a Firmware download and install drivers for the RAID mode to your operating system.

3-1 RAID Modes

There are three RAID modes that are supported by the AOC-USAS-L4i/L4IR Add-on Card:

- **IT Mode (Initiator and Target Mode):** This is the default mode for the AOC-USAS-L4i/L4IR Add-on Card. The maximum support for this mode is up to 122 hard disk drives under expander topology. This mode does not support RAID.

This mode requires an IT mode firmware flash to the BIOS and an IT mode driver installation to the OS.

- **IR Mode (Integrated RAID Mode):** In Integrated Raid™ mode the integrated ARM chip on the AOC-USAS-L4i/L4IR Add-on Card creates Integrated Mirroring™ (IM, RAID 1), Integrated Mirroring Enhanced (IME, RAID 1E) and Integrated Striping (IS, RAID 0) through the chipset's BIOS and the system's OS. The maximum support for this IR mode is up to 63 hard disk drives under an expander topology.

See [Chapter 7: "Integrated Mirroring and Integrated Mirroring Enhanced" on page 7-1](#) and [Chapter 8: "Integrated Striping" on page 8-1](#) for details on Integrated Mirroring Enhanced or Integrated Striping.

This RAID mode requires an IR mode firmware flash to the BIOS and an IT mode driver installation to the OS.

- **SR (Software RAID):** In this mode you must buy the I-Button feature from SuperMicro to enable RAID level 5 use. First you must create RAID level 0, 1, 5 or 10 from the MegaRAID BIOS Configuration Utility in order for the OS to see the hard disk drives (this can be done via MSM too, so necessary need to be done in MegaRAID Configuration Utility). The maximum support for this RAID mode is up to eight (8) hard disk drives under expander topology.

This RAID mode requires an SR mode firmware flash to the BIOS and an SR mode driver installation to the OS. This mode also requires that the SWR5 jumper on the AOC-USAS-L4IR add-on card is enabled (see [Section 2-2: "Front Jumper Locations and Pin Definitions" on page 2-3](#) for details).



NOTE: MegaRAID Storage Manager (MSM) software version 2.60 or later supports both SR and IR Mode in both Windows and Linux. MSM does not support IT Mode since IT is only an initiator and target mode, and therefore it does not required storage management utility.

3-2 Getting Firmware Downloads

Firmware for RAID modes can only be obtained through contacting SuperMicro Technical Support for instructions and assistance to obtain firmware downloads.

Each of the RAID modes requires a different firmware download. Make sure the firmware download corresponds to the RAID mode (IT, IR or SR) that you wish to use before installing it.

3-3 Flashing Firmware

Follow the procedure below to flash firmware to the BIOS.

Flashing Firmware:

1. Before Flashing the Firmware and BIOS, please erase all the flash part first. Boot to DOS and run the *Clear.BAT* file by entering the following command at the DOS prompt:

```
a:\>Clear.BAT
```

This clears all the content from the flash memory.

2. Reboot the system before doing the Firmware and BIOS flash.
3. Flash the BIOS using the ****.BAT* file with the following command at the DOS prompt (where ***** represents the name of the BAT file used):

```
a:\>***.BAT
```

This automatically flashes the BIOS.

4. The BAT file will flash Firmware and BIOS on the screen. Manually enter the SAS address when prompted.
5. When the flashing is completed, reboot the system.

The new firmware is now flashed to your system's BIOS.

3-4 Downloading RAID Mode Drivers

To obtain drivers go to the SuperMicro FTP site and down the appropriate driver for the operating system you are using.

The drivers can be found at the following FTP site:

ftp://ftp.supermicro.com/driver/SAS/LSI/1064_1068/

See the installation text file within each download for details on the installation of these drivers.

3-5 Activating RAID Modes in OPROM BIOS

RAID modes can be activated by pressing keyboard keys in the OPROM BIOS setup. Press **CTRL-C** for IT or IR mode and **CTRL-M** for SR mode to activate your system for one of these modes.

Notes

Chapter 4

MegaRAID BIOS Configuration Utility

The LSI™ MegaRAID® BIOS Configuration Utility (CU) is used to configure disk arrays and virtual drives and to do other configuration tasks in a pre-boot environment. This utility is primarily used for SR Mode configurations for the AOC-USAS-L4i/L4IR Add-on Card.

4-1 Performing a Quick Configuration

The below procedure for quickly configuring arrays and logical drives with the MegaRAID BIOS CU is intended for users that are already familiar with configuration utilities and tools. Refer to [Section 4-2](#) for detailed configuration instructions. To ensure the best performance, select the optimal RAID level for the logical drive you create.



WARNING: It is recommended that you do not use both SAS and SATA drives in the same array. Using different drive interfaces in this way could cause unpredictable behavior, decreased performance, an increased error count and decreased Mean Time Between Failures (MTBF).

Use the following procedure for quickly configuring arrays and logical drives using the MegaRAID BIOS CU:

1. Boot the system.
2. Start the MegaRAID BIOS CU by pressing CTRL+M.
3. Select CONFIGURE from the MANAGEMENT menu.
4. Select a configuration method from the CONFIGURATION menu. You may choose from either EASY CONFIGURATION, NEW CONFIGURATION or VIEW/ADD CONFIGURATION.
5. Create arrays using the available physical drives.
6. Define the logical drive(s) using the space in the arrays.
7. Initialize the new logical drive(s).

4-2 Configuring Arrays and Logical Drives

This section provides instructions for configuring arrays and logical drives with the MegaRAID BIOS CU.

It is recommended that you use drives with the same capacity when you create a storage configurations. If you use drives with different capacities in one array, the CU limits each drive to the capacity of the smallest drive.

The number of physical drives in a specific array determines the possible RAID levels that you can implement with the array. See [Section 2-4: "RAID Minimum Drive Requirements"](#) on page 2-5 for further details.

Starting the MegaRAID BIOS CU

Follow these steps to start the MegaRAID BIOS CU:

1. During boot-up, wait for the following message to appear on the screen:

Press Ctrl-M to run LSI Software RAID Setup Utility

2. When you see this message, hold down the CTRL key while pressing the M-KEY.

The RAID CONFIGURATION UTILITY MANAGEMENT MENU screen appears, as shown in [Figure 4-1](#).

Figure 4-1. RAID Configuration Utility Management Menu Screen

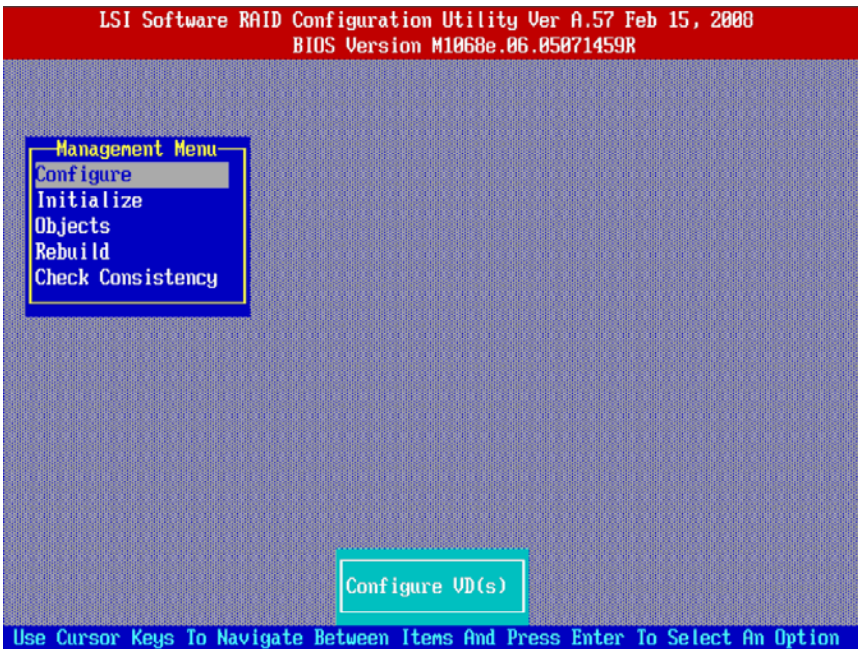

Using Easy Configuration

When you select the Easy Configuration Option, the CU creates one or more arrays from the available physical drives and configures each array as a single virtual drive. If virtual drives have already been configured, the CU does not change their configuration.

Follow the steps below to create a virtual drive using EASY CONFIGURATION:

1. Select CONFIGURATION → EASY CONFIGURATION from the MANAGEMENT menu.

A list of available (READY) physical drives appears.

2. Use the arrow keys to select the physical drives you want to include in the array.

- a. Press the SPACEBAR to add each selected physical drive to the new array.

When you select a physical drive, its status changes from READY to ONLIN A[*array number*]-[*drive number*]. For example,

ONLIN A00-01 means array 0, disk drive 1.

- b. To create a global hotspare drive, highlight a READY disk drive and press F4. Then select YES from the pop-up menu.
- c. To define multiple arrays, select all the drives you want for the first array, then press ENTER to start selecting drives for the second array, and so on.

When you have selected drives for all desired arrays, press F10.

3. Press the SPACEBAR to select an array.

The VIRTUAL DRIVES CONFIGURED screen appears, as shown in [Figure 4-2](#). This screen shows the virtual drive number, RAID level, virtual drive size, number of stripes in the physical array, stripe size, and state of the virtual drive.

Press F10 again.

Figure 4-2. Virtual Drives Configured Screen

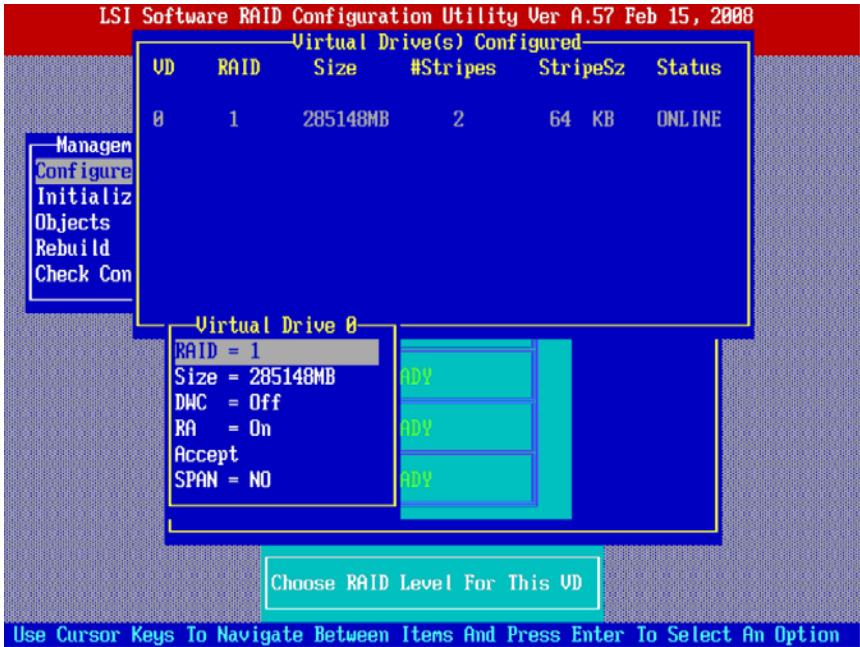

4. Highlight RAID and press ENTER.
 The available RAID levels for the current virtual drive are displayed.
5. Select a RAID level for the virtual drive and press ENTER.
6. (Optional) Change the drive's default Write Cache and Read Ahead policies (see [Section 4-3: "Setting the Hard Disk Write Cache and Read Ahead Policies" on page 4-8](#)).
7. When you have finished defining the current virtual drive, select ACCEPT and press ENTER.
8. Save the configuration when prompted, and press any key to return to the MANAGEMENT menu.
13. Initialize the new virtual drive(s) (see ["Initializing Virtual Drives" on page 4-6](#) for detailed instructions.)

Using New Configuration and View/Add Configuration

When you select the **NEW CONFIGURATION** menu option, the CU deletes the existing arrays and virtual drives and replaces them with the new configuration that you specify. The **VIEW/ADD CONFIGURATION** menu option lets you view the existing configuration or add to the existing configuration, if possible.



WARNING: If you want to keep the existing data on the storage configuration, use **VIEW/ADD CONFIGURATION** instead of **NEW CONFIGURATION**.

Follow these steps to configure a disk array using the **NEW CONFIGURATION** or **VIEW/ADD CONFIGURATION** option:

1. **SELECT CONFIGURATION** → **NEW CONFIGURATION** or **CONFIGURATION** → **VIEW/ADD CONFIGURATION** from the **MANAGEMENT** menu.

If you selected **NEW CONFIGURATION**, select **YES** to proceed and confirm that you are erasing the existing storage configuration.

The CU displays an array selection window.



NOTE: The existing storage configuration will be erased only if you save the newly created configuration at the end of the process. If you do not save the new configuration, the CU will restore the previously existing configuration.

2. Use the arrow keys to select physical drives for the new array.
3. Press the **SPACEBAR** to add each selected physical drive to the new array.

When you select a drive, its status changes from **READY** to **ONLIN A[array number] - [drive number]**. For example, **ONLIN A00-01** means array 0, disk drive 1.

4. To create a global hotspare drive, highlight a **READY** disk drive and press **F4**. Then select **YES** from the pop-up menu.

Make sure the capacity of the hotspare drive is equal to or larger than the capacity of the disks in the array and that it is the same type of drive (**SAS** or **SATA**).



NOTE: The hotspare drive will rebuild a failed drive even if it is **SAS** and the failed drive is **SATA**, or vice versa. Once the rebuild is completed, however, it is recommended that you replace the new array member with a drive of the same type.

5. To define multiple arrays, select all the drives you want for the first array, then press **ENTER** to start selecting drives for the second array, and so on.
6. When you have selected drives for all desired arrays, press **F10**.
7. Press the **SPACEBAR** to select an array, if needed.

Press **F10** to continue.

8. Highlight **RAID** and press **ENTER**.

A list of the available RAID levels for the current virtual drive appears.

9. Select a RAID level for the virtual drive and press **ENTER**.
10. (Optional) You may also set the logical drive size by highlighting **SIZE** and then pressing **ENTER**.

The minimum valid virtual drive size is 64 Mbytes. An error will appear if you try to create a virtual drive that is smaller 64 Mbytes.

By default, all the available space in the array is to the current virtual drive. For RAID 10 arrays, only one virtual can be defined for the entire array.

11. (Optional) You may change the disks's default *Write Cache* and *Read Ahead* policies (see [Section 4-3: "Setting the Hard Disk Write Cache and Read Ahead Policies" on page 4-8](#)).
12. When you have finished defining the current virtual drive, select **ACCEPT** and press **ENTER**.
13. Configure additional virtual drives on the same array, if desired.
If you have created more than one array, configure a virtual drive on the second array.
14. Save the configuration when prompted, and press any key to return to the **MANAGEMENT** menu.
15. Initialize the new virtual drive(s). (See ["Initializing Virtual Drives" on page 4-6](#) for detailed instructions.)

Creating a Global Hotspare Drive

The MegaRAID BIOS CU enables you to create global hotspare drives (dedicated hotspare drives are not supported). A hotspare drive can automatically replace a failed drive in a redundant RAID 1 or RAID 10 array, to protect against data loss.



WARNING: When you select disk drive for a global hotspare, be sure it is the same type of drive (either SAS or SATA) as the drives in the arrays that it will protect. It is recommended that you do not combine SAS and SATA drives in the same array.

You can create a hotspare when you are configuring a new storage configuration, as described in the previous sections.

Adding a Hotspare Drive

To add a hotspare drive to an existing redundant storage configuration, use the following steps:

1. Select **OBJECTS** from the **MANAGEMENT** menu.
2. Select **PHYSICAL DRIVE**.

A list of physical drives appears.

3. Select an un-configured drive or READY drive from the list, and press ENTER.
4. When the PHYSICAL DRIVE PROPERTY menu appears, select MAKE HOT SPARE and press ENTER.
5. Select YES from the pop-up menu to create the hotspare drive.

Removing a Hotspare Drive

To remove a hotspare drive

1. Select OBJECTS from the MANAGEMENT menu.
2. Select PHYSICAL DRIVE.

A list of physical drives appears.

3. Select the HOTSP disk and press ENTER
4. Select FORCE OFFLINE and press ENTER.

The status of the drive changes to READY, and it can then be used in another new array.

Initializing Virtual Drives



WARNING: When you initialize a virtual drive all existing data on the virtual drive is erased.

This section explains the two methods of initializing a virtual drive with the MegaRAID BIOS CU.

If the FAST INIT property is enabled, *fast initialization* is used. In fast initialization, the MegaRAID BIOS CU quickly writes zeroes to the first and last 8 Mbyte regions of the new virtual drive.

If the FAST INIT property is *not* enabled, the MegaRAID BIOS CU performs a *complete initialization* on the virtual drive. This may take a long time if the physical disk drives are large.

First Initialization Method

Follow these steps to initialize a virtual drive using the INITIALIZE menu.

1. On the MANAGEMENT menu, select INITIALIZE.
2. Use the SPACEBAR to highlight the virtual drive to initialize.

The virtual drive name is highlighted in yellow. To deselect it, highlight the virtual drive and press the SPACEBAR again.

3. Press F10.
4. Select YES at the prompt and press ENTER to begin the initialization.

A graph shows the progress of the initialization until it is complete.

5. After the initialization is complete, press ESC to return to previous menus.

If you press ESC while initialization is in progress, the following options appear:

- **Stop:** (Available only if *AutoResume* is enabled on the adapter: MANAGEMENT menu → OBJECTS → ADAPTER → AUTORESUME.) The initialization is stopped, and the CU stores the percentage of the initialization already completed. If *AutoResume* is enabled, and if Fast Init is not enabled, the initialization resumes where it left off when you restart it, instead of starting over from zero percent.
- **Continue:** The initialization continues normally.
- **Abort:** The initialization is completely aborted. If you restart initialization, it begins at zero percent.

Second Initialization Method

Follow these steps to initialize a virtual drive using the OBJECTS menu.

1. From the MANAGEMENT menu, select OBJECTS → VIRTUAL DRIVE, as shown in [Figure 4-3](#).

The VIRTUAL DRIVES LIST screen appears ([Figure 4-3](#)).

Figure 4-3. Virtual Drives List Screen

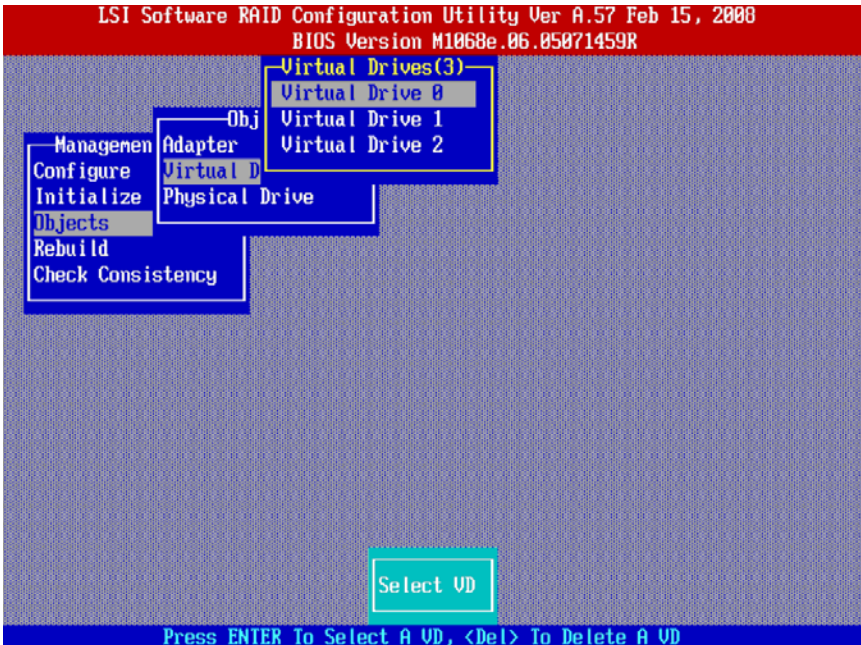

2. Select a virtual drive, if there is more than one configured, and press ENTER.

3. Select INITIALIZE from the submenu and press ENTER.
4. Select YES at the prompt and press ENTER.

The CU displays a bar graph showing the initialization progress.

5. When initialization completes, press ESC to return to the previous menu.

If you press ESC while initialization is in progress, the STOP, CONTINUE, and ABORT options are available, as explained earlier in "[First Initialization Method](#)", [step 5](#) above.

4-3 Setting the Hard Disk Write Cache and Read Ahead Policies

You can use the MegaRAID BIOS CU to set the hard disk drive *Write Cache* and *Read Ahead* settings. Any read or write cache policy changes apply to all virtual drives on an array. In other words, if two virtual drives are defined on a single array and you change the *Read Ahead* setting on one virtual drive, the change will also apply to the other virtual drive on the array.

The *Disk Write Cache* and *Read Ahead* policies can be set to ON or OFF.

- When the disk *Write Cache* is ON, a write transaction is considered to be complete when all the data has been written to the disk cache. When disk *Write Cache* is OFF, the write transaction is complete only when the data has been written to the disk.
- When disk *Read Ahead* is ON, extra data is read sequentially ahead of the data that is actually requested and is stored in a cache. If the additional read-ahead data is then requested, it can be read faster from the cache than from the disk directly.



NOTE: When the disk *Write Cache* is ON, there is a danger that data could be lost if the power fails before the cached data is written to disk.

Follow these steps to view or change the virtual drive *Write Cache* or *Read Ahead* settings:

1. From the MANAGEMENT menu, select OBJECTS → VIRTUAL DRIVE → VIRTUAL DRIVE N → VIEW/UPDATE PARAMETERS.
2. Use the arrow key to move the cursor to DISK WC or READ AHEAD and press ENTER.
3. Use the arrow key to select OFF or ON for DISK WC (DWC) or READ AHEAD.
4. When you see the prompt, CHANGE DWC or CHANGE READ AHEAD, use the arrow key to select OFF or ON, then press ENTER to change the cache setting.

The settings are changed for all virtual drives defined on the array.

4-4 Rebuilding a Drive

The MegaRAID BIOS CU enables you to rebuild a drive of a redundant array if the array has a failed drive. If the failed drive is still good (that is, if the drive is physically present and its size is greater than or equal to the defined size of the array) it will be rebuilt. If the drive is small, an error message will appear and the MegaRAID BIOS CU will not allow the drive to be rebuilt. A rebuild cannot be started on a failed drive if its size is even 1 byte smaller than the defined size of the array.

Rebuilding a Drive

Follow these steps to rebuild a drive:

1. Select REBUILD from the MANAGEMENT menu.
2. When the list of drives appears, highlight the FAIL drive that you want to rebuild and press the SPACEBAR to select it.
3. After selecting the physical drive, press F10 and select YES at the confirmation prompt.

The rebuild process begins, and a graph shows the progress of the rebuild until it is complete. Although the CU changes the disk drive state to REBUILD at this point, the change does not appear on the screen while the rebuild is in progress.

When rebuild is complete, the CU displays the message:

```
Rebuilding of Drive X Completed Successfully. Press Esc. (X
= the ID of the rebuilt drive.)
```

4. Press ESC to display the MANAGEMENT menu.

The state of the rebuilt disk drive changes from FAIL to ONLIN.

If the CU detects a media error on the source drive during rebuild, it initiates a sector read for that block.

If the sector read fails, the CU adds entries to the Soft Bad Block Management (SBBM) table, writes this table to the target drive, and displays an error message. Additional error messages are displayed if the SBBM table is 80% full or 100% full. If the SBBM table is completely full, the rebuild operation is aborted, and the drive is marked as FAIL.

If you press ESC while the rebuild is running, the following options display:

- **Stop:** (Available only if AutoResume is enabled on the adapter: MANAGEMENT MENU → OBJECTS → ADAPTER → AUTORESUME) The rebuild is stopped, and the CU stores the percentage of the rebuild already completed. If AUTORESUME is enabled, and if FAST INIT is not enabled, the rebuild resumes where it left off when you restart it instead of starting over from 0 percent.
- **Continue:** The rebuild continues normally.
- **Abort:** The rebuild is completely aborted. If you restart the rebuild, it begins at 0 percent.

4-5 Hot Plug Support

MegaRAID BIOS CU supports hot plugging of disk drives. When you insert or remove a disk drive, the following hot plug message appears:

```
A Drive Has Been Inserted/Removed. Configuration Updated.  
Press ESC...
```

After you press Esc the inserted or removed drive will be reflected in the list of drives that appears in the configuration utility.

Obviously, you should not insert or remove a drive while you are defining a new virtual drive or while an initialization or other process is running. The following information describes how the CU handles hot plugging when various actions occur:

- If the PHYSICAL DRIVE window or one of the CONFIGURATION windows is open when you insert or remove a drive, the window will close when the hot plug message appears.
- CU menus such as SELECT BOOT DRIVE, SELECT ADAPTER and VIRTUAL DRIVE will completely or partially close when a drive is inserted or removed.
- If a *Rebuild* is in progress when you insert or remove a drive, the CU first displays the message:

```
Rebuilding Of Drive Not Complete! Press Esc..
```

followed by the hot plug message.

If the Rebuild was not affected by this hot plug event, it continues to rebuild from where it left off, provided that AUTO RESUME is enabled; otherwise, the Rebuild starts over from the beginning. If the rebuilding array was affected by the hot plug event, the Rebuild aborts and the array status changes based on the hot plug operation.

- If an Initialization is in progress when you insert or remove a drive, the CU displays the message:

```
Initialization of Array Not Complete! Press ESC..
```

followed by the hot plug message.

- If a consistency check is in progress when you insert or remove a drive, the CU displays the message

```
CC Not Completed! Press ESC..
```

followed by the hot plug message.

4-6 Checking Data Consistency

The Check Consistency feature can be used on RAID 1 or RAID 10 virtual drives to verify the data consistency between the mirrored physical drives. MegaRAID BIOS CU automatically corrects any differences found in the data when a consistency check is run.

Checking Data Consistency

1. On the MANAGEMENT menu select CHECK CONSISTENCY and press ENTER.
A list of configured virtual drives is displayed.
2. Highlight a virtual drive with the arrow keys.
3. Press the SPACEBAR to select the virtual drive to check for consistency.



NOTE: If you select a RAID 0 virtual drive, a message appears stating that a Check Consistency cannot be performed. To continue, deselect the virtual drive, highlight a redundant virtual drive, and press the SPACEBAR again.

4. Press F10.
5. At the prompt, select YES to start the Check Consistency process and press ENTER.
A graph shows the progress of the Check Consistency operation until it is complete.

If the MegaRAID BIOS CU finds any data inconsistencies while comparing the source and target drives, it fixes the inconsistency by writing the source data to the target drive. When this happens, the following message appears at the bottom of the screen:

The Data on the Drives is inconsistent. Repair done!

If the MegaRAID BIOS CU finds a media error on the source drive, it pops up a dialog box with this message:

Error in Reading Sectors! Proceed Anyway (Y/N)?

If you press Y, the program skips the bad block and continues. If you press N, the program aborts the consistency check. The same message appears if the program finds a hard media error on the target drive.

If you press Esc while a Check Consistency is running, the following options are displayed:

- **Stop:** (Available only if AutoResume is enabled on the adapter by selecting: MANAGEMENT MENU? → OBJECTS? → ADAPTER? → AUTORESUME.) The Check Consistency is stopped, and the CU stores the percentage of the task already completed. If AUTORESUME is enabled, the Check Consistency resumes where it left off when you restart it, instead of starting over from zero percent.
- **Continue:** The Check Consistency continues normally.
- **Abort:** The Check Consistency is completely aborted. If you restart it, it begins at zero percent.

4-7 Viewing and Changing Device Properties

The MegaRAID BIOS CU allows you to view properties for adapters, virtual drives, and physical drives. You can also change some properties for adapters and virtual drives.

Viewing and Changing Adapter Properties

To view or change adapter properties, follow these steps:

1. On the MANAGEMENT menu, select OBJECTS → ADAPTER.
2. Select an adapter from the list. The following list of adapter properties appears:

Table 4-1. List of Adapter Properties

Property	Options	Default
Rebuild Rate	0 to 100 (% of system resources)	30
Clk Const Rate	0 to 100 (% of system resources)	30
FGI Rate (Foreground Initialization rate)	0 to 100 (% of system resources)	30
BGI Rate (Background Initialization rate)	0 to 100 (% of system resources)	30
Disk WC (Disk Write Cache)	Off, On	Off (Write Through enabled)
Read Ahead	On, Off	On
BIOS State	Enable, Disable	Enable
Stop on Error	No, Yes	No
Fast Init	Enable, Disable	Enable
Auto Rebuild	On, Off	On
Auto Resume	Enable, Disable When enabled you can stop a consistency check, rebuild, or initialization and resume it later where it left off, instead of aborting it and starting over	Enable
Disk Coercion ^a	None, 128MB, 1GB	1GB

- The Disk Coercion property can be accessed only when no configuration is present for the adapter. Otherwise, an error message appears.
 3. If you want to change the value of a property, highlight it and press ENTER.
 4. Select or type a different value for the property and press ENTER.
 5. When you are finished, press ESC until you return to the MANAGEMENT menu.

Viewing and Changing Virtual Drive Properties

To view or change virtual drive properties, follow these steps:

1. On the MANAGEMENT menu, select OBJECTS → VIRTUAL DRIVE.
2. Select VIEW/UPDATE PARAMETERS.

The only virtual drive properties you can change are Disk WC (Disk Write Cache) and Read Ahead (see [Section 4-3: "Setting the Hard Disk Write Cache and Read Ahead Policies" on page 4-8](#)). The other properties are view-only.

Notes

Viewing Physical Drive Properties

To view physical drive properties, follow these steps:

1. On the MANAGEMENT menu, select OBJECTS → PHYSICAL DRIVE.
2. Highlight a physical drive on the list that appears and press ENTER.
3. Select DRIVE PROPERTIES from the menu.

The drive properties are DEVICE TYPE (DISK), CAPACITY, PRODUCT ID, and REVISION NO. These properties are view-only.

4-8 Forcing Drives Online or Offline

The MegaRAID BIOS CU enables you to force drives online or offline. You may want to force a drive of a redundant array offline so that a hotspare drive will automatically replace it. An auto rebuild will begin immediately if the MegaRAID BIOS CU finds a valid hotspare drive to replace the offline drive.

You may need to force a drive online if it has gone offline due to a power failure. The MegaRAID BIOS CU will not allow a drive to be forced online if its size is smaller than the defined size of the array.

To force a drive online or offline, follow these steps:

1. On the MANAGEMENT menu, select OBJECTS → PHYSICAL DRIVE.
2. Highlight a physical drive that is a member of an array and press ENTER.
3. Select FORCE OFFLINE or FORCE ONLINE from the menu.

If the drive was online, its status changes to FAIL. If it was offline, its status changes to ONLIN.

4-9 Configuring a Bootable Virtual Drive

The default boot virtual drive is **LD 0**. If you change the boot drive to another virtual drive, the BIOS and the CU will preserve this change. However, if you delete the new boot virtual drive, you must be sure to configure another virtual drive for booting. The MegaRAID BIOS CU will not automatically select a different boot virtual drive.

Follow these steps to configure a bootable virtual drive:

1. On the MANAGEMENT menu, select CONFIGURE → SELECT BOOT DRIVE.
2. Select a virtual drive from the list to be the designated boot drive.

4-10 Deleting a Virtual Drive

The MegaRAID BIOS CU allows you to delete any single virtual drive defined in the configuration (sometimes referred to as random deletion).



WARNING: Before you delete a virtual drive, be sure to back up all the data you want to keep.

To delete a specified virtual drive, follow these steps:

1. Select OBJECTS → VIRTUAL DRIVE.
2. Highlight the virtual drive that you want to delete and press DELETE.
3. Select YES when the confirmation message appears.

4-11 Clearing a Storage Configuration



WARNING: Before you clear a storage configuration, be sure to back up all the data you want to keep.

To clear a storage configuration, follow these steps:

1. On the MANAGEMENT menu, select CONFIGURE → CLEAR CONFIGURATION.
2. When the message appears, select YES to confirm.

All virtual drives are deleted from the configuration.

Notes

Chapter 5

MegaRAID Overview and Installation

This chapter explains provides and overview of MegaRAID Storage Manager software, and instructions on how to install (or reinstall) the software on your workstation or server for the supported operating systems, which include: Microsoft Windows, Red Hat Linux, and SUSE Linux. 5.3.1 Installing MegaRAID Storage Manager Software on Microsoft Windows.

5-1 Overview

MegaRAID Storage Manager software enables you to configure, monitor, and maintain storage configurations created under Embedded MegaRAID Software. The MegaRAID Storage Manager graphical user interface (GUI) makes it easy for you to create and manage storage configurations.



NOTE: MegaRAID Storage Manager software can be used to manage a wide range of MegaRAID controllers. Some MegaRAID Storage Manager software features are not applicable for Embedded MegaRAID Software.

Creating Storage Configurations

MegaRAID Storage Manager software enables you to easily configure the controllers, disk drives, and virtual disks on your workstation or server. The Configuration Wizard greatly simplifies the process of creating arrays and virtual disks.

You can use the Configuration Wizard's *Auto Configuration mode* to automatically create the best possible configuration with the available hardware. You can use the *Guided Configuration mode*, which asks you a few brief questions about the configuration, and then creates it for you. Or you can use the *Manual Configuration mode*, which gives you complete control over all aspects of the storage configuration.

Monitoring Storage Devices

MegaRAID Storage Manager software displays the status of virtual disks, physical disks, and other storage devices on the workstation or server that you are monitoring. System errors and events are recorded in an event log file and are displayed on the screen. Special device icons appear on the screen to notify you of disk failures and other events that require immediate attention.

Maintaining Storage Configurations

You can use MegaRAID Storage Manager software to perform system maintenance tasks such as running consistency checks on arrays that support redundancy.

5-2 Hardware and Software Requirements

The hardware requirements for MegaRAID Storage Manager software are as follows:

- PC-compatible computer with an IA-32 (32-bit) Intel Architecture processor or an EM64T (64-bit) processor and at least 128 Mbytes of system memory (256 Mbytes recommended)
- Hard disk drive with at least 50 Mbytes available free space

The supported operating systems for the MegaRAID Storage Manager software are as follows:

- Microsoft Windows 2000, Microsoft Windows Server 2003, Microsoft Windows XP, Microsoft Vista and Microsoft Windows Server 2008.
- Red Hat Linux 3.0 or 4.0
- SUSE SLES 9, with latest updates and service packs

Refer to your server documentation and to the operating system documentation for more information on hardware and operating system requirements.

5-3 Installing for Windows

Follow these steps if you need to install MegaRAID Storage Manager software on a system running Microsoft Windows 2000, Microsoft Windows Server 2003, or Microsoft Windows XP:

1. Insert the MegaRAID Storage Manager software installation CD in the CD-ROM drive.

If necessary, find and double-click the *setup.exe* file to start the installation program.

2. When the WELCOME screen appears, click NEXT.

If MegaRAID Storage Manager software is already installed on this system, the PROGRAM MAINTENANCE screen appears. Read the screen text and select MODIFY, REPAIR, or REMOVE.

3. When the next screen appears, read and accept the user license, and click NEXT.

The CUSTOMER INFORMATION screen appears, as shown in [Figure 5-1](#).

Figure 5-1. Customer Information Screen

Megaraid Storage Manager v1.00-01 - InstallShield Wizard

Customer Information

Please enter your information.

User Name:
Administrator

Organization:
MegaComputer

Allow availability of this application for:

All users

Only for current user (Administrator)

InstallShield

< Back Next > Cancel

4. Enter your user name and organization name, and in the bottom part of the screen, select an installation option:
 - If you select **ALL USERS**, any user with administrative privileges can use this version of MegaRAID Storage Manager software to view or change storage configurations.
 - If you select **ONLY FOR CURRENT USER**, the MegaRAID Storage Manager shortcuts and associates icon availability to only the user with this screen's user name.

Click **NEXT** to continue.

5. On the next screen, accept the default destination folder, or click **CHANGE** to select a different destination folder.

Click **NEXT** to continue.

The **SETUP TYPE** screen appears, as shown in [Figure 5-2](#).

Figure 5-2. Setup Type Screen

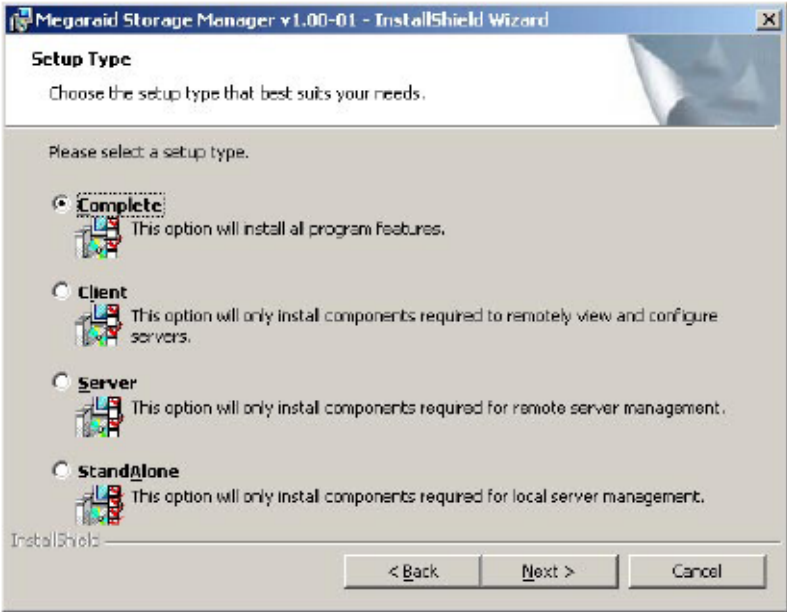

6. Select one of the Setup options. The options are fully explained in the screen text.
 - Select COMPLETE if you are installing MegaRAID Storage Manager software on a server.
 - Select CLIENT if you are installing MegaRAID Storage Manager software on a PC that is used to view and configure servers over a network.
 - Select SERVER to install only those components required for remote server management.
 - Select STANDALONE if you are using MegaRAID Storage Manager software to create and manage storage configurations on a standalone workstation.

Click NEXT to proceed.

7. On the next screen, click INSTALL to install the program.
8. Click FINISH when the final CONFIGURATION WIZARD screen appears.

If you select CLIENT installation for a PC used to monitor servers, and if there are no available servers with a registered framework on the local subnet (that is, servers with a complete installation of MegaRAID Storage Manager software), you cannot connect to a remote server unless you first edit the *startupui.bat* file. Specifically, you must add the IP address of the remote server to the end of the *startupui.bat* file.

For example, to connect to a remote framework on server 192.168.0.10, add the IP address to the end of *startupui.bat* as shown in this example:

```
start JRE\bin\javaw -classpath .;GUI.jar
GUI.VivaldiStartupDialog ajsgyqkj=71244 192.168.0.10
```

Be sure to include a space in front of the IP address, as shown in the above example.

5-4 Installing for Linux

Follow these steps if you need to install MegaRAID Storage Manager software on a system running Red Hat Linux or SUSE Linux:

1. Copy the *MSM_linux_installer...tar.gz* file to a temporary folder.
2. Untar the *MSM_linux_installer...tar.gz* file using the following command:

```
tar -zxvf MSM_linux_installer...tar.gz
```

A new disk directory is created.

3. Go to the new disk directory, and in that directory find and read the *readme.txt* file.
4. To start the installation, enter the following command:

```
./install.sh
```

If you select CLIENT installation for a PC used to monitor servers, and if there are no available servers with a registered framework on the local subnet (that is, servers with a complete installation of MegaRAID Storage Manager software), you cannot connect to a remote server unless you first edit the *startupui.sh* file. Specifically, you must add the IP address of the remote server to the end of the *startupui.sh* file.

For example, to connect to a remote framework on server 192.168.0.10, add the IP address to *startupui.sh* as shown in this example:

```
start JRE\bin\javaw -classpath .;GUI.jar
GUI.VivaldiStartupDialog ajsgyqkj=71244 192.168.0.10
```

Be sure to include a space in front of the IP address, as shown in the above example.

Linux Error Messages

One or more of the following messages may appear while you are installing MegaRAID Storage Manager software on a Linux system:

- More than one copy of MegaRAID Storage Manager software has been installed.

This message indicates that the user has installed more than one copy of MegaRAID Storage Manager software. (This can be done by using the *rpm-force* command to install the *rpm* file directly, which is not recommended, instead of using the *install.sh* file.) In such cases, the user must uninstall all the *rpm* files manually before installing MegaRAID Storage Manager software with the procedure listed previously.

- The version is already installed.

This message indicates that the version of MegaRAID Storage Manager software you are trying to install is already installed on the system.

- The installed version is newer.

This message indicates that a version of MegaRAID Storage Manager software is already installed on the system, and it is a newer version than the version you are trying to install.

- Exiting installation.

This is the message that appears when the installation is complete.

- RPM installation failed.

This message indicates that the installation failed for some reason. Additional message text explains the cause of the failure.

Chapter 6

MegaRAID Window and Menus

The MegaRAID Storage Manager software is a configuration and monitoring utility used with the Embedded MegaRAID Software. This chapter provides instruction on its use and features.

6-1 Starting MegaRAID Storage Manager Software

Follow these steps to start MegaRAID Storage Manager software and view the main window:

1. Start the program using the method required for your operating system environment:
 - To start MegaRAID Storage Manager software on a Microsoft Windows system, select START → PROGRAMS → MEGARAID STORAGE MANAGER → STARTUPUI, or double-click the MEGARAID STORAGE MANAGER shortcut on the desktop.



NOTE: If a warning appears stating that Windows Firewall has blocked some features of the program, click UNBLOCK to allow MegaRAID Storage Manager software to start.

This is because Windows Firewall sometimes blocks the operation of programs that use Java.

- To start MegaRAID Storage Manager software on a Red Hat Linux system, select APPLICATIONS → SYSTEM TOOLS → MEGARAID STORAGE MANAGER → STARTUPUI.
- To start MegaRAID Storage Manager software on a SUSE SLES 9 system, select START → SYSTEM → MORE PROGRAMS → MEGARAID STORAGE MANAGER.

When the program starts, the SELECT SERVER window appears ([Figure 6-1](#)).

Figure 6-1. Select Server Window

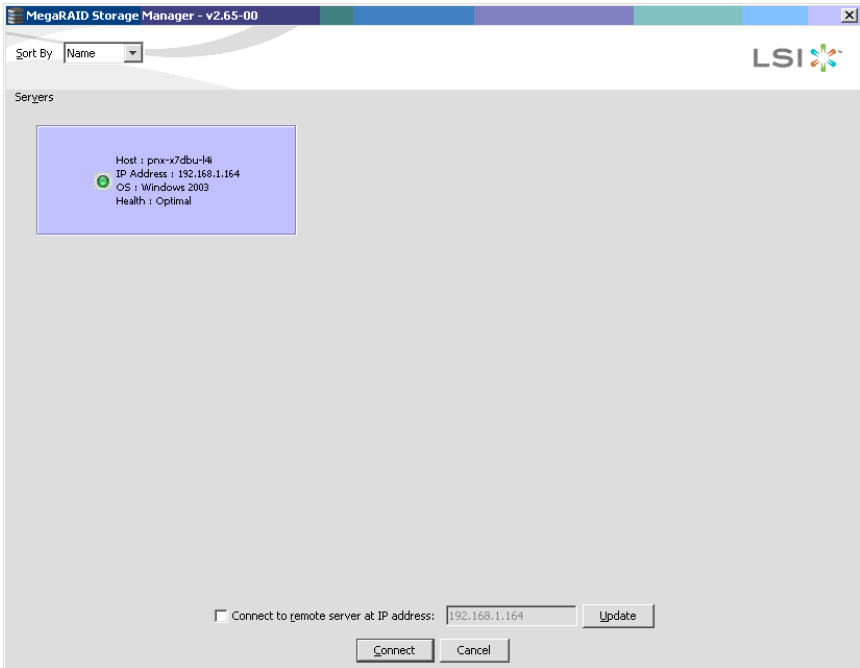

If the circle in the server icon is yellow instead of green, it means that the server is running in a degraded state—for example, because a disk drive used in a virtual disk has failed. If the circle is red, the storage configuration in the server has failed.



NOTE: To access servers on a different subnet, type in the box at the bottom of the screen the IP address of a server in the desired subnet where MegaRAID Storage Manager software is running, and click UPDATE. If you check the Connect to remote Framework box, you can also access a standalone installation of MegaRAID Storage Manager software, if it has a network connection.

2. Double-click the icon of the server that you want to access.

The SERVER LOGIN window appears (Figure 6-2).

Figure 6-2. Server Login Window

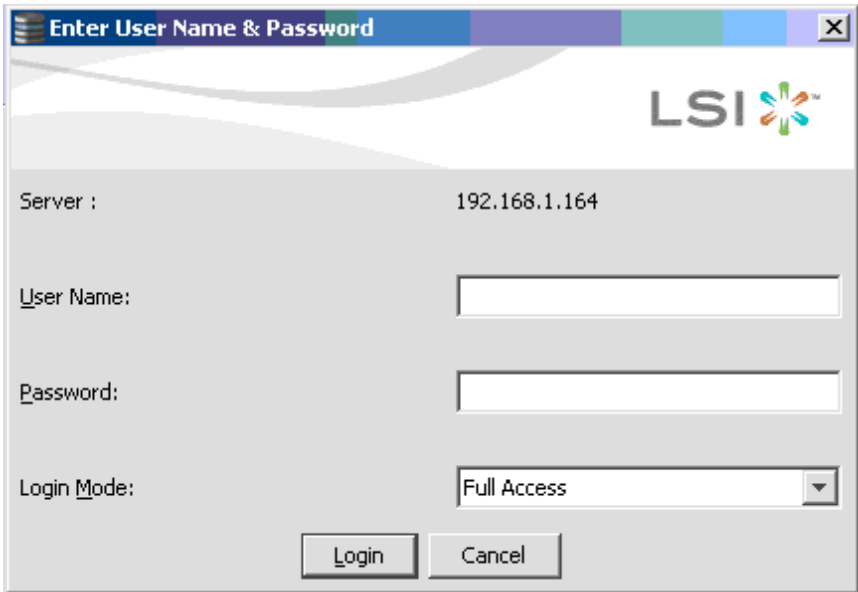

Enter User Name & Password

LSI

Server : 192.168.1.164

User Name:

Password:

Login Mode: Full Access

Login Cancel

3. Select an access mode from the drop-down menu.
 - Select FULL ACCESS if you need to both view the current configuration and change the configuration.
 - Select VIEW ONLY if you need to only view and monitor the configuration.
4. Enter your user name and password, and click LOGIN.



NOTE: If the computer is net worked, this is the login to the computer itself, not the network login.

You must enter the root/administrator user name and password to use Full Access mode. If your user name and password are correct for the Login mode you have chosen, the main MEGARAID STORAGE MANAGER window appears.

6-2 MegaRAID Storage Manager Window

This section describes the MEGARAID STORAGE MANAGER window (Figure 6-3).

Figure 6-3. Storage Manager Window

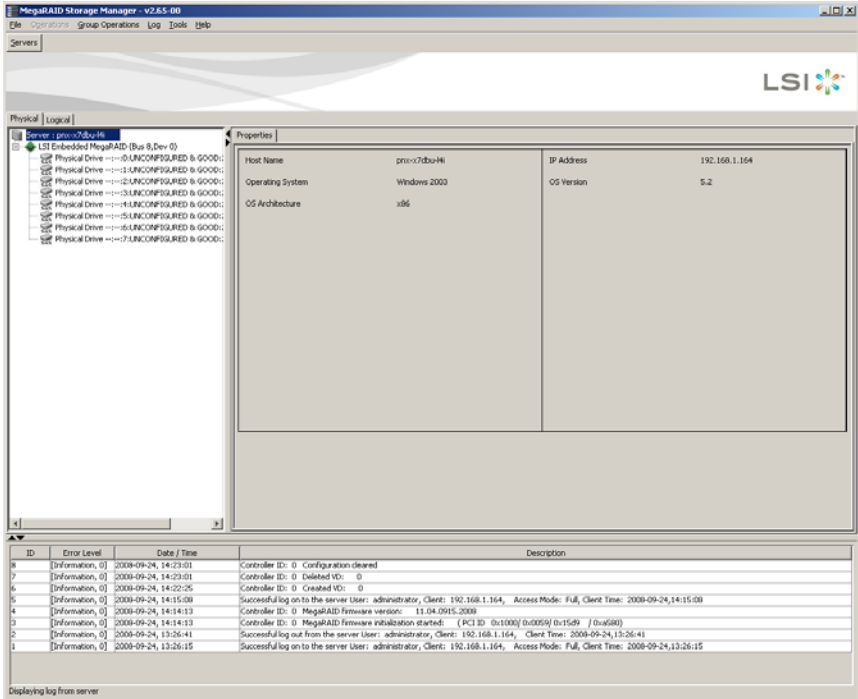

The following sections describe the panels and menu options that appear in this window.

Physical/Logical View Panel

The left panel of the MEGARAID STORAGE MANAGER window displays either the Physical view or the Logical view of the system and the devices in it, depending on which tab is selected.

- The Physical view shows the hierarchy of physical devices in the system. At the top of the hierarchy is the system itself. One or more controllers are installed in the system. Each controller has one or more ports. Disk drives and other devices are attached to the ports.
- The Logical view shows the hierarchy of controllers, virtual disks, and disk groups that are defined on the system. (Physical drives also appear in the Logical view, so you can see which physical drives are used by each virtual disk.)

The following icons in the left panel represent the controllers, disk drives, and other devices:

- System
- Controller
- Port
- Array
- Virtual disk
- Physical drive

A red circle to the right of an icon indicates that the device has failed.

A yellow circle to the right of an icon indicates that a device is running in a degraded state.

Properties/Operations/Graphical View Panel

The right panel of the MEGARAID STORAGE MANAGER window has either two or three tabs, depending on what kind of device is selected in the left panel.

- The PROPERTIES tab displays information about the selected device. For example, if a controller icon is selected in the left panel, the PROPERTIES tab lists information such as the controller name and the device port count.
- The OPERATIONS tab lists the operations that can be performed on the device that is selected in the left panel. Some types of devices, such as arrays and ports, do not have operations associated with them.
- The GRAPHICAL VIEW tab can be selected in the right panel if a physical drive or virtual disk is selected in the left panel. In graphical view, the device's storage capacity is color coded according to the legend shown on the screen. For example, on a physical drive configured space is blue, available space is white, and reserved space is red.

Event Log Panel

The lower part of the MEGARAID STORAGE MANAGER window displays the system event log entries. New event log entries appear during the session. Each entry has a timestamp and date, an error level indicating the severity of the event, and a brief description of the event.

Menu Bar

This section contains brief descriptions of the main selections from the MEGARAID STORAGE MANAGER menu bar.

File Menu

The FILE menu has an EXIT option for exiting from the MEGARAID STORAGE MANAGER software. It also has a RESCAN option for updating the display in the MEGARAID STORAGE MANAGER window. (RESCAN is seldom required; the display normally updates automatically.)

Operations Menu

The OPERATIONS menu is available when a controller, physical drive, or logical drive is selected in the MEGARAID STORAGE MANAGER window. The OPERATIONS menu options vary depending on what type of device is selected in the left panel of the MEGARAID STORAGE MANAGER window. The options also vary depending on the current state of the selected device. For example, if you select an offline physical drive, the MAKE DRIVE ONLINE option appears in the OPERATIONS menu.

You can also view the OPERATIONS selections on the main window on the OPERATIONS tab in the right panel. If an operation requires user inputs before it can be executed, it appears in the OPERATIONS tab but not in the OPERATIONS menu. A device-specific OPERATIONS menu pops up if you right-click a device icon in the left panel.

An ADVANCED OPERATIONS submenu is also available. This is where you access the CONFIGURATION WIZARD and other configuration-related commands. To access this menu, select OPERATIONS → ADVANCED OPERATIONS.

Group Operations Menu

The GROUP OPERATIONS menu options include CHECK CONSISTENCY, INITIALIZE, and SHOW PROGRESS.

Log Menu

The LOG menu includes options for saving and clearing the message log.

Help Menu

On the HELP menu you can select HELP → HELP to view the MegaRAID Storage Manager software online help file. You can select HELP → ABOUT to view version information for the MegaRAID Storage Manager software.



NOTE: When you use the MegaRAID Storage Manager software online help, you may see a warning message that Internet Explorer has restricted the file from showing active content. If this warning appears, click on the active content warning bar and enable the active content.

6-3 Creating a New Storage Configuration

You may use MegaRAID Storage Manager software to also create and modify storage configurations. The RAID 0, RAID 1, RAID 5 and RAID 10 storage configurations are supported using this software.



WARNING: It is recommended that you do not use both SAS and SATA drives in the same array. Using different drive interfaces in this way could cause unpredictable behavior, decreased performance, an increased error count, and decreased MTBF.



NOTE: You cannot create or modify a storage configuration unless you are logged on with administrator privileges.

To open the MegaRAID Storage Manager Configuration Wizard, select a controller in the left panel of the MEGARAID STORAGE MANAGER window and then select OPERATIONS → ADVANCED OPERATIONS → CONFIGURATION → CONFIGURATION WIZARD.

This brings up the Configuration Wizard's MODE SELECTION screen (Figure 6-4).

Figure 6-4. Mode Selection Screen

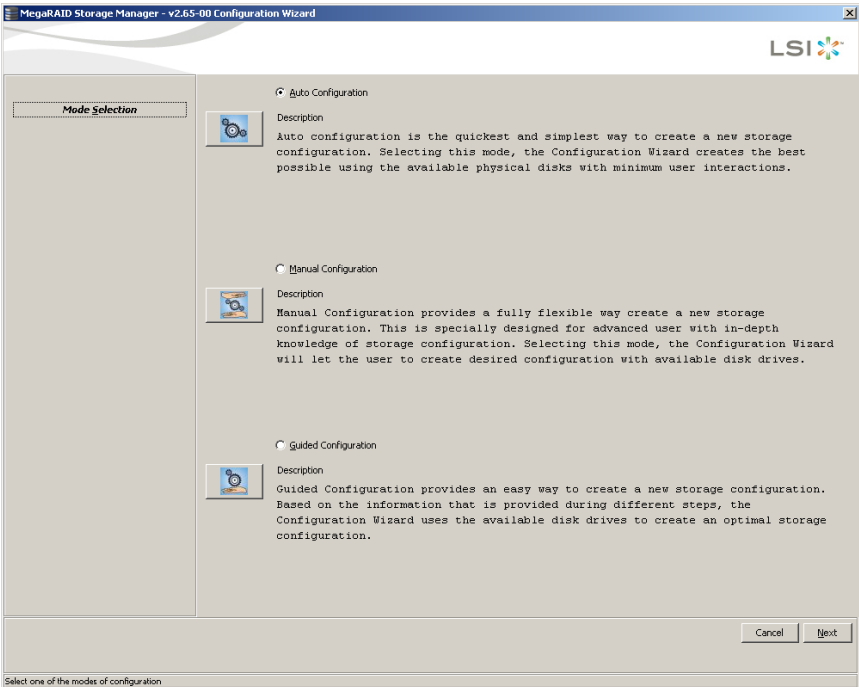

The menu lists three configuration modes:

- **Auto Configuration** automatically creates an optimal configuration from the available disk drives.
- **Manual Configuration** gives you the greatest level of control in creating a new virtual disk.
- **Guided Configuration** asks you a few simple questions about what kind of configuration you want and then automatically creates it from the available disk drives.



NOTE: You can use AUTO, GUIDED, or MANUAL CONFIGURATION mode to create a RAID 0, or RAID 1 configuration. To create a RAID 10 configuration, you must use the MANUAL CONFIGURATION mode.

Understanding Virtual Disk Parameters

This section describes the Virtual Disk Parameters that you can set when you use the Guided Configuration or Manual Configuration modes of the Configuration Wizard. You should change these parameters only if you have a specific reason for doing so. It is usually best to leave them at their default settings.

- **Stripe Size:** A stripe size of 64 Kbytes is supported.
- **Disk Cache Policy:** Select a cache setting for this disk: Unchanged, Enabled, or Disabled.
- **Init State**
 - **No Initialization:** The new configuration is not initialized and the existing data on the disks is not overwritten.
 - **Fast Initialization:** MegaRAID Storage Manager software quickly writes zeroes to the first and last 8 Mbyte regions of the new virtual disk.
 - **Full Initialization:** A complete initialization is done on the new configuration. This may take a long time if the disks are large.

Using Auto Configuration

Auto Configuration is the quickest and simplest way to create a new storage configuration. When you select AUTO CONFIGURATION mode on the first CONFIGURATION WIZARD screen, the Configuration Wizard creates the best configuration possible using the available physical disks and displays them in the AUTO CONFIGURATION screen (see [Figure 6-5](#)).

Figure 6-5. Auto Configuration Screen

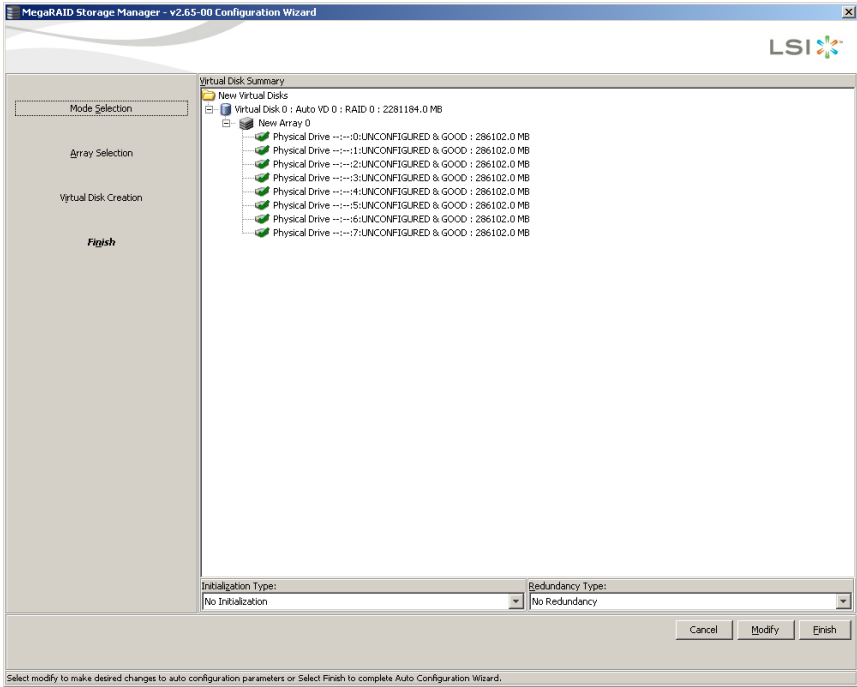

Follow these steps to create a new storage configuration in Auto Configuration mode:

1. Select a redundancy option from the drop-down menu at the bottom of the AUTO CONFIGURATION screen:
 - **No Redundancy:** The new configuration will have no data redundancy (RAID 0). If a physical disk in the configuration fails, all data will be lost.
 - **With Redundancy:** The new configuration will have data redundancy via mirrored data (RAID 1) or via parity data (RAID 5). If a physical disk fails, data is still protected.
2. Select an initialization option from the drop-down menu at the bottom of the screen:
 - **No Initialization:** Using this option, new configuration is not initialized and the existing data on the disks is not overwritten.
 - **Fast Initialization:** Using this option, MegaRAID Storage Manager software quickly writes zeroes to the first and last 8 Mbyte regions of the new virtual disk.
 - **Full Initialization:** If you select this option, a complete initialization is done on the new configuration. This may take a long time if the disks are large.

3. (Optional) Click MODIFY if you want to switch to Manual Configuration mode so you can modify the suggested Auto Configuration.

When you click MODIFY, the VIRTUAL DISK CREATION screen appears. In this screen do the following:

- a. Select the new virtual disk, and click RECLAIM.
 - b. Select the new array from the ARRAYS WITH FREE SPACE list, and change the virtual disk parameters as needed.
4. Click FINISH.

The new storage configuration will be created and initialized (unless you selected NO INITIALIZATION).

Using Guided Configuration

Guided Configuration provides an easy way to create a new storage configuration. Based on the information that is provided, the Configuration Wizard uses the available disk drives to create an optimal storage configuration (see [Figure 6-6](#)).

Figure 6-6. First Guided Configuration Screen

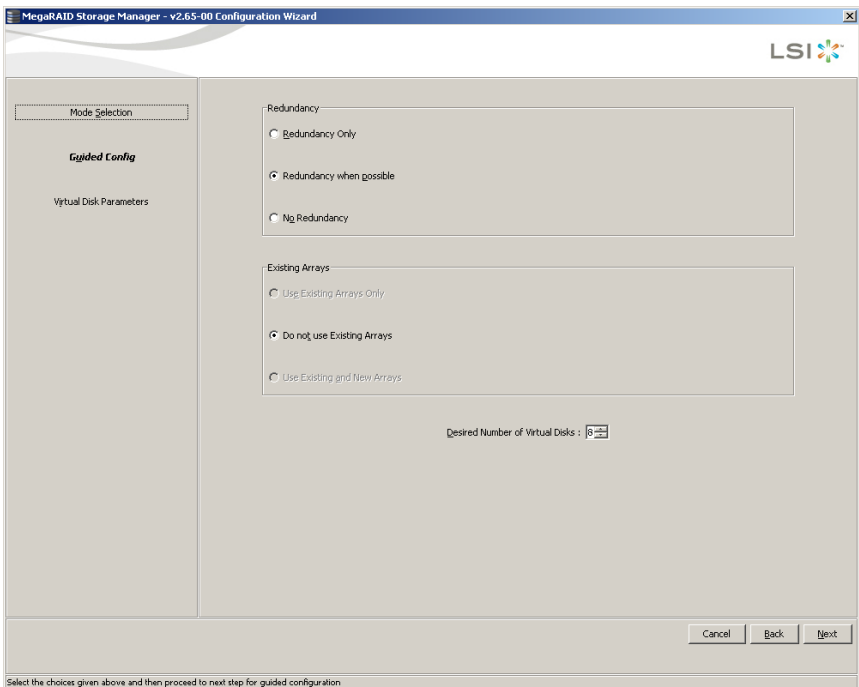

Follow these steps to create a new storage configuration in Guided Configuration mode:

1. Select a redundancy option at the top of the GUIDED CONFIGURATION screen:
 - **Redundancy Only:** This option creates a configuration only if redundancy (RAID 1 or RAID 5) is possible.
 - **Redundancy When Possible:** This option creates a redundant configuration if possible. Otherwise, this creates a non-redundant configuration.
 - **No Redundancy:** This option creates a non-redundant configuration.
2. Choose whether you want to use existing arrays in the new virtual disk. The options are:
 - **Use Existing Arrays Only**
 - **Don't Use Existing Arrays**
 - **Use Existing and New Arrays**

The first and third options are disabled if there are no available existing arrays.
3. Select a maximum number of virtual disks to be created. The Configuration Wizard may not be able to create as many virtual disks as you want, depending on the current configuration and the number of virtual disks that have already been created.

4. Click NEXT to continue to the next screen (see Figure 6-7).

Figure 6-7. Second Guided Configuration Screen

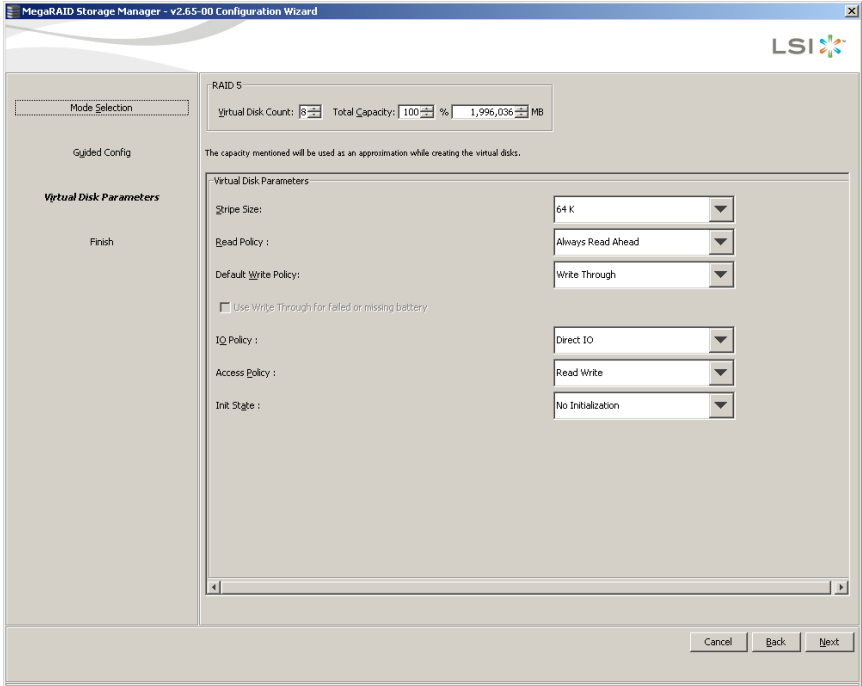

5. Change the default volume parameters in this screen, if needed. In the top section of the window you can specify the number of virtual disks to create. You can also choose to use less than the full capacity of this array for the virtual disk(s).



NOTE: You may choose to do this in order to leave capacity available for other virtual disks that you create later.

6. Click NEXT to continue to the next screen.
7. Check the configuration that you have just defined. If it is acceptable, click FINISH. If you want to change something, click BACK to return to the previous screens.

Using Manual Configuration: RAID 0

Follow these steps to create a RAID 0 storage configuration using the Manual Configuration mode of the Configuration Wizard.

Figure 6-8 shows the first screen that appears when you select MANUAL CONFIGURATION.

Figure 6-8. Manual Configuration – First Manual Configuration Screen

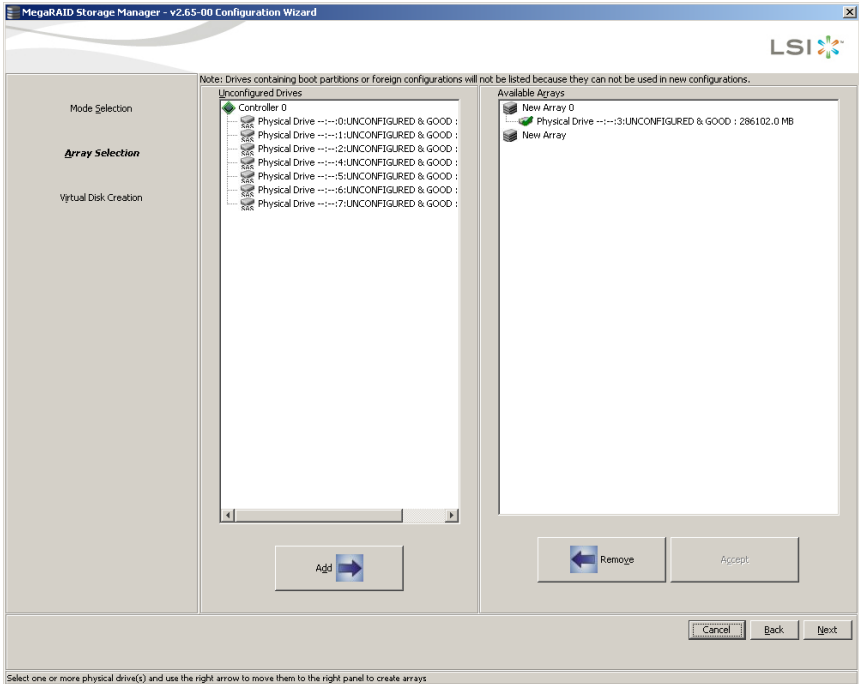

1. In this first screen, select two or more available drives in the left panel. Click the right ADD arrow button to move the selected drives to the right panel.



NOTE: MegaRAID Storage Manager software will not allow you to select the disk drive on which the operating system is installed or any other drives that are already part of a configuration.

2. Click ACCEPT to accept these drives for the new RAID 0 array.



NOTE: To remove a single drive from a proposed new array, select the drive icon in the right panel and click the left REMOVE arrow button.

3. Click NEXT.

The DEFINING A VIRTUAL DISK screen of the Configuration Wizard appears, as shown in [Figure 6-9](#).

Figure 6-9. Defining a Virtual Disk Screen

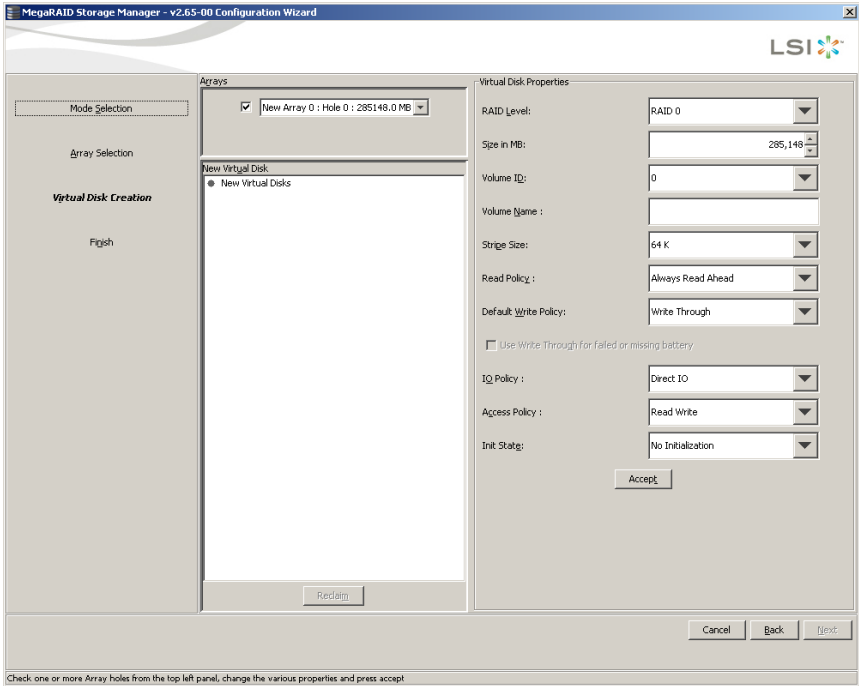

The ARRAYS menu lists the new array that you just defined, plus any existing arrays with holes (free space) that could be used for a new configuration.

4. From the ARRAYS menu, select the array to use for the new virtual disk.
5. In the right VIRTUAL DISK PROPERTIES panel, select RAID 0 as the RAID level.
6. (Optional) Set Size (in MB) to a lower number if you do not want to use the entire available capacity for the new virtual disk.
7. (Optional) Change the other properties in the VIRTUAL DISK PROPERTIES panel, if necessary.
8. Click ACCEPT to accept the configuration of the new virtual disk.



NOTE: Click the RECLAIM button if you want to undo a virtual disk that you just defined.

9. Click NEXT to continue with the next configuration step. The VIRTUAL DISK SUMMARY screen appears.
10. Review the configuration shown in the VIRTUAL DISK SUMMARY screen. If you want to change something, click BACK and change the configuration parameters.
11. Click FINISH to accept the configuration and start the initialization process (unless you selected No Initialization earlier).

Using Manual Configuration: RAID 1

Follow these steps to create a RAID 1 storage configuration using the Manual Configuration mode of the Configuration Wizard:

1. In the FIRST MANUAL CONFIGURATION screen, shown in [Figure 6-8](#), select two available drives in the left panel. Click the right arrow button to move the selected drives to the right panel.



NOTE: MegaRAID Storage Manager software will not allow you to select the disk drive on which the operating system is installed or any other drives that are already part of a configuration.

2. Click ACCEPT to accept these drives for the new RAID 1 array.
3. Click NEXT.

The next Configuration Wizard screen appears, as shown in [Figure 6-9](#).

The ARRAYS menu lists the new array(s) that you just defined, plus any existing arrays with holes (free space) that could be used for a new configuration.

4. Select the array to use for the new virtual disk.
5. In the right panel, select RAID 1 as the RAID level.
6. (Optional) SET SIZE (in MB) to a lower number if you do not want to use the entire available capacity for the new virtual disk.
7. (Optional) Change the other VIRTUAL DISK PROPERTIES, if necessary.
8. Click ACCEPT to accept the configuration of the new virtual disk.



NOTE: Click the RECLAIM button if you want to undo a virtual disk that you just defined.

9. Click NEXT to continue with the next configuration step.
The VIRTUAL DISK SUMMARY screen appears.
10. Review the configuration shown in the screen. If you want to change something, click BACK and change the configuration parameters.
11. Click FINISH to accept the configuration and start the initialization process (unless you selected NO INITIALIZATION earlier).

Using Manual Configuration: RAID 5

Follow these steps to create a RAID 5 storage configuration using the Manual Configuration mode of the Configuration Wizard. You must buy the I-Button feature from SuperMicro to enable RAID level 5 use.

1. In the first MANUAL CONFIGURATION screen (Figure 6-8), select three available drives in the left panel. Click the right arrow button to move the selected drives to the right panel.



NOTE: MegaRAID Storage Manager software will not allow you to select the disk drive on which the operating system is installed or any other drives that are already part of a configuration.

2. Click ACCEPT to accept these drives for the new RAID 5 array.



NOTE: To remove a single drive from a proposed new array, select the drive icon in the right panel and click the left arrow button.

3. Click NEXT.

The next CONFIGURATION WIZARD screen appears (Figure 6-9). The ARRAYS menu lists the new array that you just defined, plus any existing arrays with holes (free space) that could be used for a new configuration.

4. From the ARRAYS menu, select the array to use for the new virtual disk.
5. In the right panel, select RAID 5 as the RAID level.
6. (Optional) Set SIZE (in MB) to a lower number if you do not want to use the entire available capacity for the new virtual disk.
7. (Optional) Change the other VIRTUAL DISK PROPERTIES, if necessary.
8. Click ACCEPT to accept the configuration of the new virtual disk.



NOTE: Click the RECLAIM button if you want to undo a virtual disk that you just defined.

9. Click NEXT to continue with the next configuration step. The VIRTUAL DISK SUMMARY screen appears.
10. Review the configuration shown in the VIRTUAL DISK SUMMARY screen. If you want to change something, click BACK and change the configuration parameters.
11. Click FINISH to accept the configuration and start the initialization process (unless you selected NO INITIALIZATION earlier).

Using Manual Configuration: RAID 10

Follow these steps to create a RAID 10 storage configuration using the Manual Configuration mode of the Configuration Wizard:

1. In the first MANUAL CONFIGURATION screen, shown in [Figure 6-8](#), select two available drives in the left panel. Click the right arrow button to move the selected drives to the right panel.
2. Click ACCEPT to accept these drives for a new RAID 1 array.
3. Select two more drives for a second RAID 1 array, and click ACCEPT.
4. Click NEXT.

The next CONFIGURATION WIZARD screen appears, as shown in [Figure 6-9](#). The ARRAYS menu lists the new arrays that you just defined, plus any existing arrays with holes (free space) that could be used for a new configuration.

5. In the left panel, select the two RAID 1 arrays from the menu.
6. In the right panel, select RAID 10 as the RAID level.

For a RAID 10 array, the entire capacity of the array is automatically used for the new virtual disk. You cannot define another virtual disk on this array.

7. (Optional) Change the other VIRTUAL DISK PROPERTIES, if necessary. For more information, see "[Understanding Virtual Disk Parameters](#)".
8. Click ACCEPT to accept the configuration of the new virtual disk.



NOTE: Click the RECLAIM button if you want to undo a virtual disk that you just defined.

9. Click NEXT to continue with the next configuration step. The VIRTUAL DISK SUMMARY screen appears.
10. Review the configuration shown in the screen. If you want to change something, click BACK and change the configuration parameters.
11. Click FINISH to accept the configuration and start the initialization process (unless you selected NO INITIALIZATION earlier).

6-4 Adding or Deleting a Hotspare Disks

Hotspares are disk drives that are available to automatically replace failed drives in a RAID 1, RAID 5 and RAID 10 virtual disk. Each virtual disk can have one dedicated hotspare.

For more information, see the software *Help* file for more information.

To add a global hotspare disk, follow these steps:

1. In the left panel of the MEGARAID STORAGE MANAGER window, right click the icon of any unused disk drive.
2. Click on the OPERATIONS tab of the MEGARAID STORAGE MANAGER window to display the tab (Figure 6-10).

Figure 6-10. Adding a Hotspare Disk

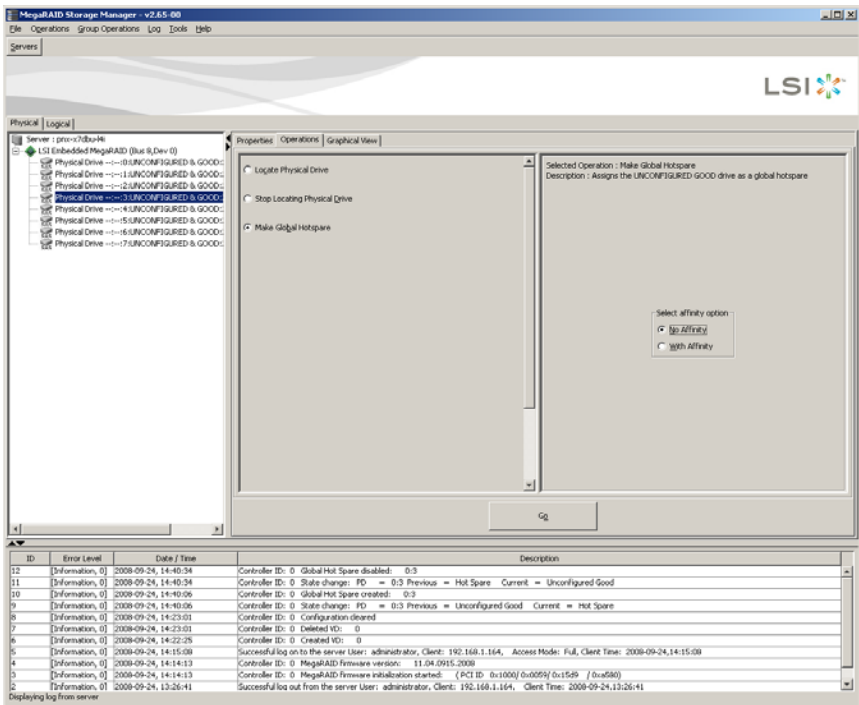

3. In the left pane of the tab, select the MAKE GLOBAL HOTSPARE option.
4. In the right pane of the tab, select your preferred AFFINITY option (NO AFFINITY or WITH AFFINITY).
5. Press the Go button to create your hotspare disk.

Make sure the capacity of the hotspare drive is equal to or larger than the capacity of the disks in the array and that it is the same type of drive (SAS or SATA).



NOTE: The hotspare drive will rebuild a failed drive even if it is SAS and the array drives are SATA, or vice versa. Once the rebuild is complete, it is recommended that you replace the new array member with a drive of the same type.

To remove a global hotspare disk, follow these steps:

1. In the left panel of the MEGARAID STORAGE MANAGER window, select a hotspare drive.
2. Click on the OPERATIONS tab of the MEGARAID STORAGE MANAGER window to display the tab (Figure 6-10).
3. In the left pane of the tab, select the REMOVE GLOBAL HOTSPARE option.
4. Press the Go button.

This brings up a dialog box for you to confirm your deletion.

5. Check CONFIRM in the dialog box and then press OK to confirm your deletion.

6-5 Changing Adjustable Task Rates

Follow these steps if you need to change the adjustable rates for rebuilds and other system tasks that run in the background:



NOTE: It is recommended that you leave the adjustable task rates at their default settings to achieve the best system performance. If you raise the task rates above the defaults, foreground tasks will run more slowly and it may seem that the system is not responding. If you lower the task rates below the defaults, rebuilds and other background tasks may run very slowly and may not complete within a reasonable time. If you decide to change the values, record the original default value here so you can restore them later, if necessary:

Rebuild Rate: _____

Background Initialization (BGI) Rate: _____

Check Consistency Rate: _____

1. Select the PHYSICAL VIEW tab in the left panel of the MEGARAID STORAGE MANAGER window, and select a controller icon.
2. In the right panel of the MEGARAID STORAGE MANAGER window, select the OPERATIONS tab, and select SET ADJUSTABLE TASK RATES.

The task rates appear in the right panel.

3. Enter changes, as needed, to the task rates for REBUILD RATE, BACKGROUND INITIALIZATION (BGI) Rate (for fast initialization), and CHECK CONSISTENCY RATE (for consistency checks).

Each task rate can be set from 0 to 100. The higher the number, the faster the activity will run in the background, possibly impacting other system tasks.

4. Click Go to accept the new task rates.
5. When the warning message appears, click OK to confirm that you want to change the task rates.

6-6 Changing Virtual Disk Properties

You can change a virtual disk's READ POLICY, WRITE POLICY, and other properties at any time after the virtual disk is created. To do this, follow these steps:

1. Select a virtual disk icon in the left panel of the MEGARAID STORAGE MANAGER window.
2. In the right panel, select the PROPERTIES tab, and then select SET VIRTUAL DISK PROPERTIES.

A list of Virtual Disk Properties appears in the right panel.

3. Change the virtual disk properties as needed in the right panel. For information on these properties, see "[Understanding Virtual Disk Parameters](#)".



NOTE: Only the Disk Write Cache and Read Ahead functions are supported in Embedded MegaRAID Software.

4. Click Go to accept the changes.

6-7 Deleting a Virtual Disk

You can delete virtual disks to rearrange the storage space.



WARNING: Be sure to back up the data on the virtual disk before you delete it. Be sure that the operating system is not installed on this virtual disk.

To delete a virtual disk, follow these steps:

1. Back up all user data that is on the virtual disk you intend to delete.
2. In the left panel of the MEGARAID STORAGE MANAGER window, select the LOGICAL tab, and click the icon of the virtual disk you want to delete.
3. In the right panel, select the OPERATIONS tab, and select DELETE VIRTUAL DISK.
4. Click Go.
5. When the warning message appears, click YES to confirm that you want to delete the virtual disk.

6-8 Saving a Storage Configuration to Disk

You can save an existing controller configuration to a file so you can apply it to another controller.

To save a configuration file, follow these steps:

1. Select a controller icon from the left panel of the MEGARAID STORAGE MANAGER window.
2. On the menu bar, select OPERATIONS → ADVANCED OPERATIONS → CONFIGURATION → SAVE CONFIGURATION.

The SAVE dialog box appears.

3. In the SAVE dialog box, type a name for the configuration file or accept the default name (*hostname.cfg*).
4. Click SAVE to save the configuration file.

6-9 Clearing a Storage Configuration from a Controller

You can use the ADD NEW CONFIGURATION option to add a new storage configuration while keeping the existing configuration. Alternatively, you can clear the existing storage configuration from a controller and then create a totally new configuration or load a previously saved configuration file.



WARNING: Before you clear a configuration, be sure to save any data that you want to keep. Clearing a configuration deletes all data from the disks of the existing configuration. Be sure that the operating system is not installed on this configuration.

To clear a configuration from a controller, follow these steps:

1. Select a controller icon in the left panel of the MEGARAID STORAGE MANAGER window.
2. On the menu bar, select OPERATIONS → ADVANCED OPERATIONS → CONFIGURATION → CLEAR CONFIGURATION.

A WARNING message appears.

3. Click YES to clear the configuration or NO to cancel the operation.

6-10 Adding a Saved Storage Configuration

When you replace a controller, or when you want to duplicate an existing storage configuration on a new controller, you can add a saved configuration to the controller.



WARNING: When you add a saved configuration to a replacement controller, be sure that the number and size of the physical disks connected to the controller are exactly the same as when the configuration was saved.

To add a saved configuration, follow these steps:

1. Select a controller icon in the left panel of the MEGARAID STORAGE MANAGER window.
2. On the menu bar, select OPERATIONS → ADVANCED OPERATIONS → CONFIGURATION → ADD SAVED CONFIGURATION.
A WARNING message appears.
3. Click YES.
4. When the OPEN dialog box appears select the configuration file, and click OPEN.
5. View the configuration detail, then select APPLY.
6. Confirm the new configuration when prompted.

Chapter 7

Integrated Mirroring and Integrated Mirroring Enhanced

This chapter provides an overview of the Integrated Mirroring (IM) and Integrated Mirroring Enhanced (IME) features. The chapter also explains how to create Integrated Mirroring (IM) and Integrated Mirroring Enhanced (IME) volumes using the SAS BIOS Configuration Utility (SAS BIOS CU), which is used to setup IR Mode.

7-1 Introduction

As a result of the shift towards Network Attached Storage (NAS), ISPs need a cost effective, fault-tolerant solution to protect the operating systems on small form factor, high-density, rack-mountable servers. The Integrated Mirroring (IM) and Integrated Mirroring Enhanced (IME) features provide data protection for the system boot volume to safeguard critical information such as the operating system on servers and high performance workstations. The IM and IME features provide a robust, high-performance, fault-tolerant solution to data storage needs, at a lower cost than a dedicated RAID controller.

To provide fault-tolerant protection for critical data, the IM and IME features support one or two mirrored volumes per SAS controller. The two volumes can contain up to twelve disk drives total, plus one or two hot spare disks.

If a disk in an Integrated Mirroring volume fails, the hot swap capability allows you to restore the volume by simply swapping disks. The firmware then automatically re-mirrors the swapped disk. Additionally, each SAS controller can have one or two global hot spare disks available to automatically replace a failed disk in the IM or IME storage volumes on the controller. Hot spares make the IM/IME volume even more fault tolerant.



NOTE: You can also configure one IM or IME volume and one Integrated Striping (IS) volume on the same SAS controller.

The IM/IME feature uses the same device drivers as the standard based controllers, providing seamless and transparent fault tolerance. This eliminates the need for complex backup software or expensive RAID hardware. The IM/IME feature operates independently from the operating system, in order to conserve system resources. The BIOS-based configuration utility makes it easy to configure IM and IME volumes.

7-2 IM and IME Features

IM and IME support the following features:

- Configurations of one or two IM or IME volumes on the same SAS controller. IM volumes have two mirrored disks; IME volumes have three to ten mirrored disks. Two volumes can have up to 12 disks total. (Requires Integrated RAID firmware v1.20.00 or above.)
- One or two global hot spare disks per controller, to automatically replace failed disks in IM/IME volumes. (Support for two hot spares requires Integrated RAID firmware v1.20.00 or above.) The hot spares are in addition to the 12-disk maximum for two volumes per SAS controller.
- Mirrored volumes run in optimal mode or in degraded mode (if one mirrored disk fails).
- Hot swap capability.
- Presents a single virtual drive to the OS for each IM/IME volume.
- Supports both SAS and SATA disks. The two types of disks cannot be combined in the same volume. However, an SAS controller can support one volume with SATA disks and a second volume with SAS disks.
- Fusion-MPT architecture.
- Easy-to-use BIOS-based configuration utility.
- Error notification: the drivers update an OS-specific event log.
- SES status LED support.
- *Write journaling*, which allows automatic synchronization of potentially inconsistent data after unexpected power-down situations.
- Metadata used to store volume configuration on mirrored disks.
- Automatic background resynchronization while host I/Os continue.
- Background media verification ensures that data on IM/IME volumes is always accessible.

7-3 IM/IME Description

The Integrated RAID solution supports one or two IM/IME volumes on each SAS controller (or one IM/IME volume and one Integrated Striping volume). Typically, one of these volumes is the boot volume, as shown in [Figure 7-1](#). Boot support is available through the firmware of the SAS controller that supports the standard Fusion-MPT interface. The runtime mirroring of the boot disk is transparent to the BIOS, drivers, and operating system. Host-based status software monitors the state of the mirrored disks and reports any error conditions. [Figure 7-1](#) shows an IM implementation with a second disk as a mirror of the first (primary) disk.

Figure 7-1. Typical Integrated Mirroring Implementation

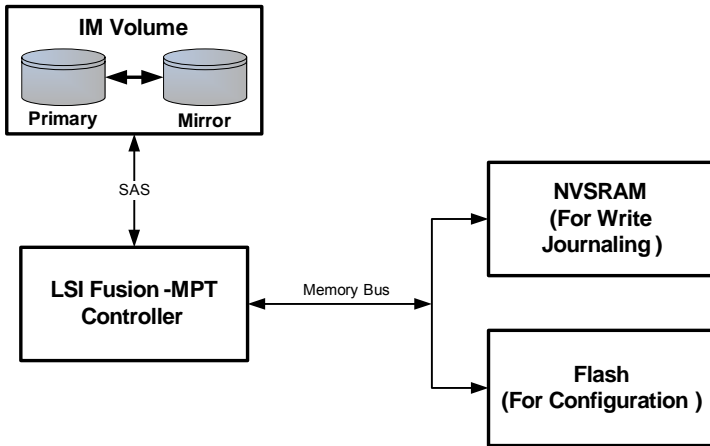

The advantage of an IM/IME volume is that there is always a second, mirrored copy of the data. The disadvantage is that writes take longer because data must be written twice. On the other hand, performance is actually improved during reads.

Figure 7-2 shows the logical view and physical view of an IM volume.

Figure 7-2. Integrated Mirroring Volume

Logical View

Physical View

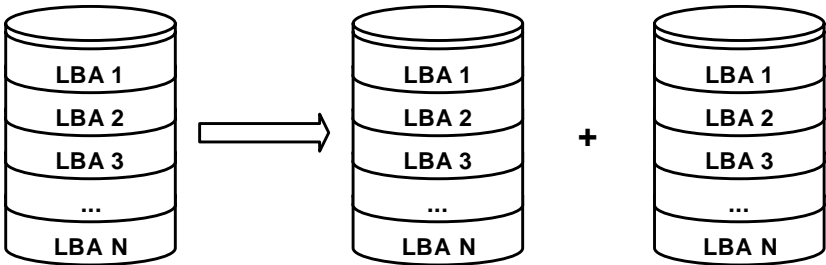

An IME volume can be configured with up to ten mirrored disks. (One or two global hot spares can be added also.) Figure 7-3 shows the logical view and physical view of an Integrated Mirroring Enhanced (IME) volume with three mirrored disks. Each mirrored stripe is written to a disk and mirrored to an adjacent disk. This type of configuration is also called RAID 1E.

Figure 7-3. Integrated Mirroring Enhanced with Three Disks

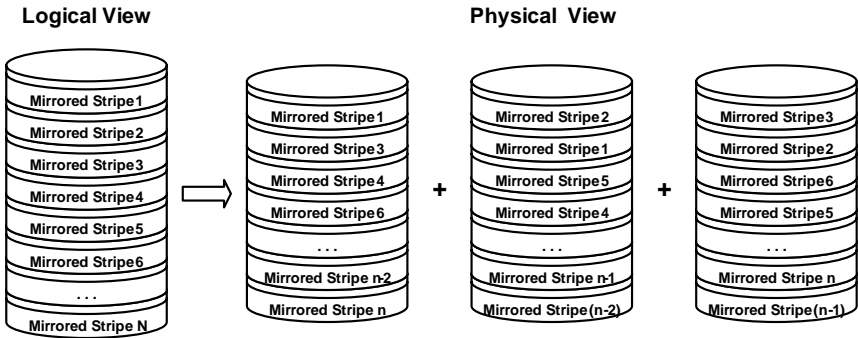

The BIOS-based configuration utility enables you to create IM and IME volumes during initial setup and to reconfigure them in response to hardware failures or changes in the environment.

7-4 Integrated RAID Firmware

This section describes features of the Integrated RAID firmware.

Resynchronization with Concurrent Host I/O Operation

The Integrated RAID firmware allows host I/Os to continue on an IM or IME volume while the volume is being re-synchronized in the background. Resynchronization is attempted after a hot spare is activated due to a physical device failure, or after a hot swap has occurred to a physical disk in the volume.

Metadata Support

The firmware supports metadata, which describes the IM/IME logical drive configuration stored on each member disk. When the firmware is initialized, each member disk is queried to read the stored metadata in order to verify the configuration. The usable disk space for each member disk is adjusted down when the configuration is created, in order to leave room for this data.

Hot Swapping

The firmware supports hot swapping. The hot-swapped disk is automatically resynchronized in the background, without any host or user intervention. The firmware detects hot swap removal and disk insertion.

Following a hot swap event, the firmware readies the new physical disk by spinning it up and verifying that it has enough capacity for the mirrored volume. The firmware resynchronizes all hot-swapped disks that have been removed, even if the same disk is re-inserted. In a two-disk mirrored volume, the firmware marks the hot-swapped disk as the secondary disk and marks the other mirrored disk as the primary disk. The firmware resynchronizes all data from the primary disk onto the new secondary disk.

SMART Support

SMART is a technology that monitors hard disk drives for signs of future disk failure and generates an alert if such signs are detected. The firmware polls each physical disk in the volume at regular intervals. If the firmware detects a SMART ASC/ASCQ code on a physical disk in the IM/IME volume, it processes the SMART data and stores it in nonvolatile memory. The IM/IME volume does not support SMART directly, since it is just a logical representation of the physical disks in the volume.

Hot Spare Disk

One or two disk drives per controller can be configured as global hot spare disks, to protect data on the IM/IME volumes configured on the controller. If the firmware fails one of the mirrored disks, it automatically replaces the failed disk with a hot spare disk and then resynchronizes the mirrored data. The firmware is automatically notified when the failed disk has been replaced, and it then designates the failed disk as the new hot spare.

Media Verification

The firmware supports a background media verification feature that runs at regular intervals when the IM/IME volume is in optimal state. If the verification command fails for any reason, the other disk's data for this segment is read and written to the failing disk in an attempt to refresh the data. The current Media Verification Logical Block Address is written to nonvolatile memory occasionally to allow media verification to continue approximately where it left off prior to a power-cycle.

Disk Write Caching

The firmware disables disk write caching by default for IM/IME volumes. This is done to increase data integrity, so that the disk write log stored in NVSRAM is always valid. If disk write caching were enabled (not recommended), the disk write log could be invalid.

NVSRAM Usage

The Integrated RAID firmware requires at least a 32K NVSRAM in order to perform write journaling. Write journaling is used to verify that the disks in the IM/IME volume are synchronized with each other.

7-5 Fusion-MPT Support

The BIOS uses the LSI Fusion-MPT® interface to communicate to the SAS controller and firmware to enable IM and IME volumes. This includes reading the Fusion-MPT configuration to access the parameters that are used to define behavior between the SAS controller and the devices connected to it. The Fusion-MPT drivers for all supported operating systems implement the Fusion-MPT interface to communicate with the controller and firmware.

7-6 IM/IME Configuration Overview

You can use the SAS BIOS CU to create one or two IM/IME volumes on each SAS controller, with one or two optional global hot spare disks. All disks in an IM/IME volume must be connected to the same SAS controller.

Although you can use disks of different size in IM and IME volumes, the smallest disk in the volume will determine the logical size of all disks in the volume. In other words, the excess space of the larger member disk(s) will not be used. For example, if you create an IME volume with two 100-GB disks and two 120-GB disks, only 100-GB of the larger disks will be used for the volume.

Refer to [Section 7-2](#) below for more information about Integrated Mirroring volumes.

7-7 Creating IM and IME Volumes

The SAS BIOS CU is part of the Fusion-MPT BIOS. When the BIOS loads during boot and you see the message about the Configuration Utility, press CTRL-C to start the CU. After you do this, the message changes to:

```
Please wait, invoking SAS Configuration Utility...
```

After a brief pause, the main menu of the SAS BIOS CU appears. On some systems, however, the following message appears next:

```
LSI Configuration Utility will load following initialization!
```

In this case, the SAS BIOS CU will load after the system has completed its power-on self test.

You can configure one or two IM or IME volumes per Fusion-MPT controller. You can also configure one IM/IME and one Integrated Striping (IS) volume on the same controller, up to a maximum of twelve physical disk drives for the two volumes. In addition, you can create one or two hot spares for the IM/IME array(s).

The following guidelines also apply when creating an IM or IME volume:

- All physical disks in a volume must be either SATA (with extended command set support) or SAS (with SMART support). SAS and SATA disks cannot be combined in the same volume. However, you can create one volume with SAS disks and a second volume with SATA disks on the same controller.
- Disks must have 512-byte blocks and must not have removable media.

- An IM volume must have two drives. An IME volume can have three to ten drives. In addition, one or two hot spares can be created for the IM/IME volume(s).



NOTE: If a disk in an IM/IME volume fails, it is rebuilt on the global hot spare if one is available. It is recommended that you always use hot spares with IM/IME volumes.

Creating an IM Volume

Follow these steps to create an IM volume with the SAS BIOS CU:

1. On the ADAPTER LIST screen (Figure 7-4), use the arrow keys to select an SAS adapter.

Figure 7-4. Adapter List Screen

LSI Corp Config Utility v6.22.00.00 (2008.04.10)
Adapter List Global Properties

Adapter	PCI Bus	PCI Dev	PCI Fnc	PCI Slot	FW Revision	Status	Boot Order
SAS3442E	00	00	00	02	1.25.01.00-IR	Enabled	0

Esc = Exit Menu F1/Shift+1 = Help
Alt+N = Global Properties -/+ = Alter Boot Order Ins/Del = Alter Boot List

- 2. Press ENTER to go to the ADAPTER PROPERTIES screen, as shown in [Figure 7-5](#) below:

Figure 7-5. Adapter Properties Screen

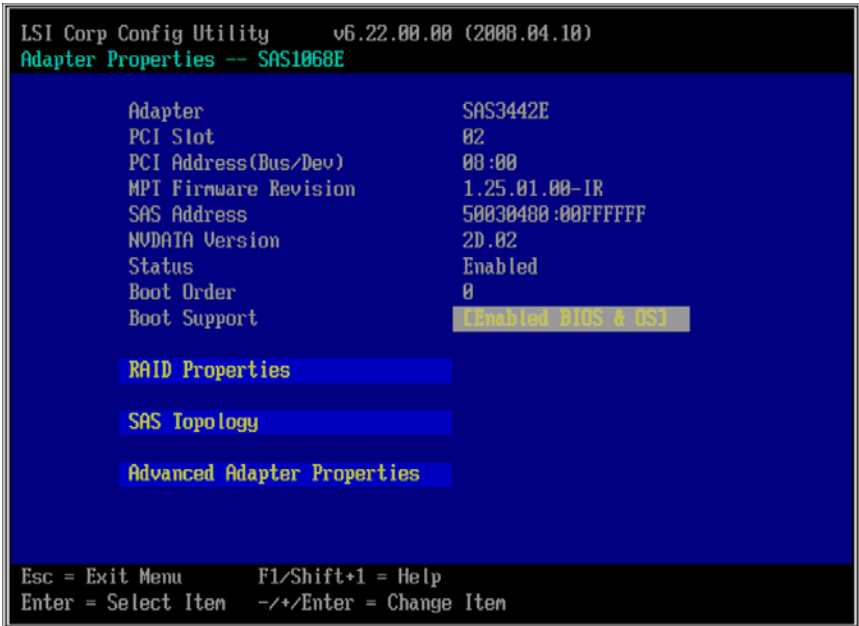

3. On the ADAPTER PROPERTIES screen, use the arrow keys to select RAID PROPERTIES on the screen and press ENTER.

The SELECT NEW ARRAY TYPE screen appears (Figure 7-6).

Figure 7-6. Select New Array Type Screen

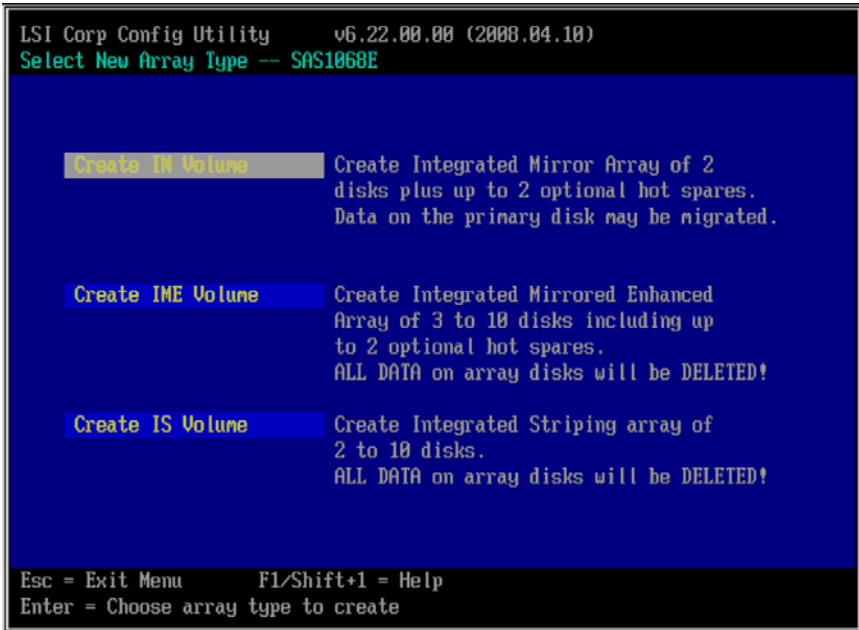

- In the SELECT NEW ARRAY TYPE screen (Figure 7-6), select CREATE IM VOLUME.

The CREATE NEW ARRAY screen appears (Figure 7-7). This screen shows a list of disks available to be added to a volume.

Figure 7-7. Create New Array Screen

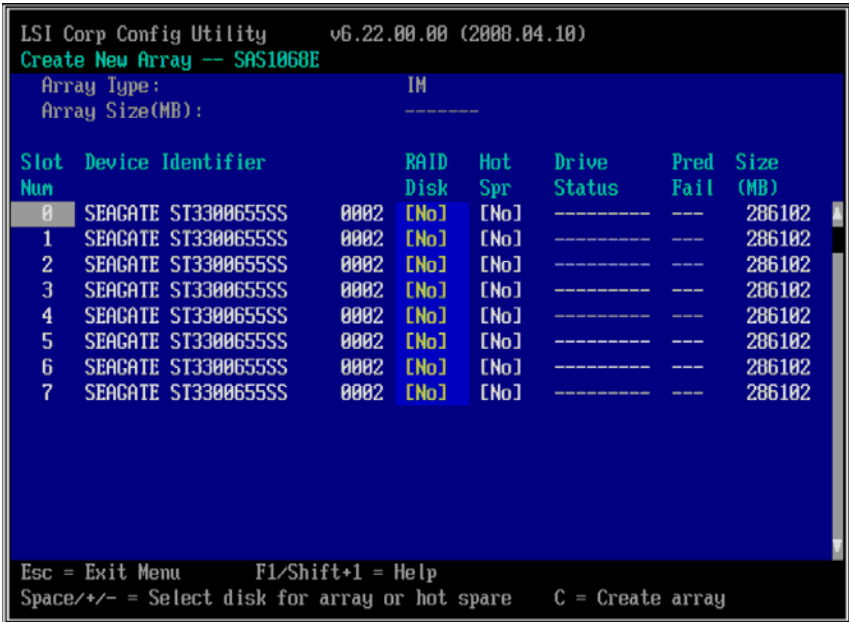

- In the CREATE NEW ARRAY screen move the cursor to the RAID Disk column and select a disk. To add the disk to the volume, change the No to YES by pressing the + key, - key, or SPACE bar.

When the first disk is added, the SAS BIOS CU prompts you to either keep existing data or overwrite existing data.

- Press **M** to keep the existing data on the first disk or press **D** to overwrite it.

If you keep the existing data, this is called a data migration. The first disk will be mirrored onto the second disk, so any data you want to keep must be on the first disk selected for the volume. Data on the second disk is overwritten. The first disk must have 512KB available for metadata after the last partition.

As disks are added the ARRAY SIZE field changes to reflect the size of the new volume.

- [Optional] Add one or two global hot spares by moving the cursor to the hot spare column and pressing the + key, - key, or SPACE bar.

Figure 7-7 shows an IM volume configured with one global hot spare disk.

8. When the volume has been fully configured, press **C** and then SAVE CHANGES. Then exit this menu to commit the changes.

The SAS BIOS CU pauses while the array is being created.

Creating an IME Volume

Follow these steps to create an IME volume with the SAS BIOS CU:

1. On the ADAPTER LIST screen, use the arrow keys to select an SAS adapter.
2. Press ENTER to go to the ADAPTER PROPERTIES screen (Figure 7-5).
3. On the ADAPTER PROPERTIES screen, use the arrow keys to select RAID PROPERTIES on the screen and press ENTER.
4. When you are prompted to select a volume type, select CREATE IME VOLUME.

The CREATE NEW ARRAY screen (Figure 7-7) shows a list of disks that can be added to a volume.

5. Move the cursor to the RAID DISK column and select a disk. To add the disk to the volume, change the No to YES by pressing the + key, - key, or SPACE bar.
6. Repeat this step to select a total of three to ten disks for the volume.

All existing data on all the disks you select will be overwritten. As you add disks, the ARRAY SIZE field changes to reflect the size of the new volume.

7. [Optional] Add one or two global hot spares to the volume by moving the cursor to the hot spare column and pressing the + key, - key, or SPACE bar.
8. 8. When the volume has been fully configured, press **C** and then select SAVE CHANGES. Then exit this menu to commit the changes.

The SAS BIOS CU pauses while the array is being created.

Creating a Second IM or IME Volume

The SAS controllers allow you to configure two IM or IME volumes per controller. If one volume is already configured, and if there are available disk drives, there are two ways to add a second volume. The first is as follows:

1. In the configuration utility, select an adapter from the ADAPTER LIST.
2. Select the RAID PROPERTIES option to display the current volume.
3. Press **C** to create a new volume.
4. Continue with either [step 4 of "Creating an IM Volume" on page 7-7](#) or [step 4 of "Creating an IME Volume" on page 7-11](#) to create a second volume.

The other way to add a second volume is as follows:

1. On the ADAPTER LIST screen, use the arrow keys to select an SAS adapter.
2. Press ENTER to go to the ADAPTER PROPERTIES screen (Figure 7-5).

3. On the ADAPTER PROPERTIES screen, use the arrow keys to select RAID PROPERTIES and press ENTER.
4. Continue with [step 4 of "Creating an IM Volume" on page 7-7](#) or [step 4 of "Creating an IME Volume" on page 7-11](#) to create a second volume.

7-8 Managing Hot Spares

You can create one or two global hot spare disks to protect the IM or IME volumes on a SAS controller. Usually, you create global hot spares at the same time you create the IM/IME volume. Follow these steps to add global hot spare disks later:

1. On the VIEW ARRAY screen, select MANAGE ARRAY.
2. Select MANAGE HOT SPARE on the MANAGE ARRAY screen ([Figure 7-8](#)).

Figure 7-8. Manage Array Screen

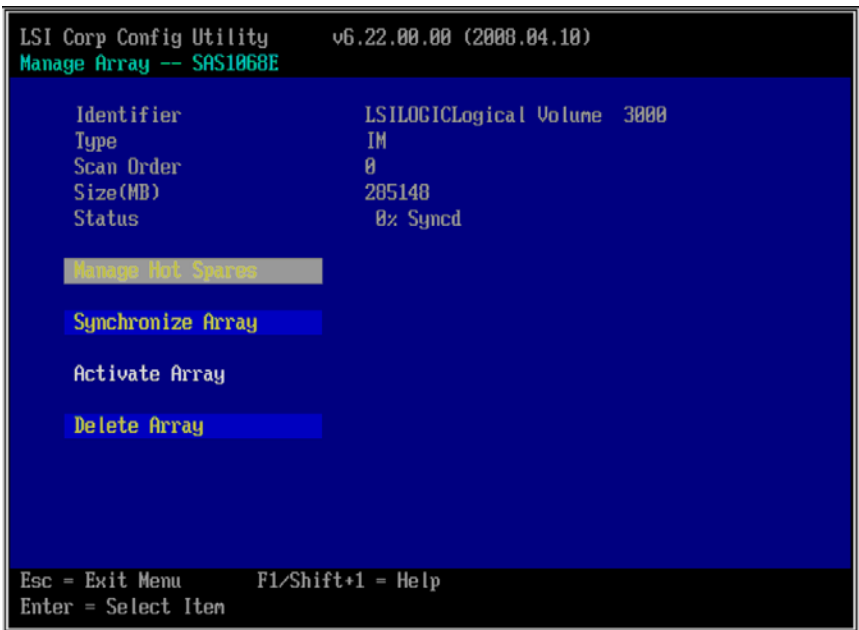

3. Select a disk from the list by pressing the + key, - key, or SPACE bar.
4. After you select the global hot spare disk, press **C**.

An error message appears if the selected disk is not at least as large as the smallest disk used in the IM/IME volume(s). The global hot spare disk must have 512-byte blocks, it cannot have removable media, and the disk type must be either SATA with extended command set support or SAS with SMART support.

If SATA disks are used for the IM/IME volume(s), the hot spare disk must also be a SATA disk. If SAS disks are used, the hot spare disk must also be a SAS disk. An error message appears if the selected disk is not the same type as the disks used in the IM/IME volumes.

5. [Optional] Select a second hot spare disk.
6. Select **SAVE CHANGES** then exit this menu to commit the changes.
The configuration utility pauses while the global hot spares are being added.

Follow these steps to delete a global hot spare:

1. Select **MANAGE HOT SPARE** on the **MANAGE ARRAY** screen (Figure 7-8).
2. Select **DELETE HOT SPARE** and then press **C**.
If there are two hot spares, select which one you want to delete.
3. Select **SAVE CHANGES** then exit this menu to commit the changes.
The configuration utility pauses while the global hot spare is being removed.

7-9 Other Configuration Tasks

This section explains how to perform other configuration and maintenance tasks for IM and IME volumes.

Viewing Volume Properties

Follow these steps to view the properties of volumes:

1. In the SAS BIOS CU, select an adapter from the **ADAPTER LIST**. Select the **RAID PROPERTIES** option.

The properties of the current volume are displayed. If global hot spares are defined, they are also listed.



NOTE: If you create one volume using SAS disks, another volume using SATA disks, and global hot spare disks, the hot spare disks will only appear when you view the volume that has the same type of disks as the hot spare disks.

2. If two volumes are configured, press **ALT+N** to view the other array.
3. To manage the current array, select **MANAGE ARRAY** and press **ENTER**.

Synchronizing an Array

The **Synchronize Array** command forces the firmware to resynchronize the mirrored disks data in the array. It is seldom necessary to use this command, because the firmware automatically keeps the mirrored data synchronized during normal operation. When you use this command, one disk of the array is placed in the *Degraded* state until the data on the mirrored disks has been resynchronized.

Follow these steps to force the synchronization of a selected array:

1. Select SYNCHRONIZE ARRAY on the MANAGE ARRAY screen (Figure 7-8).
2. Press **Y** to start the synchronization, or **N** to cancel it.

Activating an Array

An array can become inactive if, for example, it is removed from one controller or computer and moved to another one. The Activate Array option allows you to reactivate an inactive array that has been added to a system. This option is only available when the selected array is currently inactive.

Follow these steps to activate a selected array

1. Select ACTIVATE ARRAY on the MANAGE ARRAY screen (Figure 7-8).
2. Press **Y** to proceed with the activation, or press **N** to abandon it.

After a pause, the array will become active.



NOTE: If there is a global hot spare disk on the controller to which you have moved the array, the BIOS checks when you activate the array to determine if the hot spare is compatible with the new array. An error message appears if the disks in the activated array are larger than the hot spare disk or if the disks in the activated array are not the same type as the hot spare disk (SATA versus SAS).

Deleting an Array



WARNING: Before deleting an array, be sure to back up all data on the array that you want to keep.

Follow these steps to delete a selected array:

1. Select DELETE ARRAY on the MANAGE ARRAY screen (Figure 7-8).
2. Press **Y** to delete the array.

After a pause, the array is deleted. If there is another remaining array and one or two hot spare disks, the BIOS checks the hot spare disks to determine if they are compatible with the remaining array. If they are not compatible (too small or wrong disk type) the firmware deletes them also.



NOTE: After a volume has been deleted, it cannot be recovered. When an IM volume is deleted, the data is preserved on the primary disk. When an IME volume is deleted, the master boot records of all disks are deleted.

Locating Drives in a Volume

You can use the SAS BIOS CU to locate and identify a specific physical disk drive by flashing the drive's LED. You can also use the SAS BIOS CU to flash the LEDs of all the disk drives in a RAID volume. There are several ways to do this:

- When you are creating an IM or IME volume, and a disk drive is set to Yes as part of the volume, the LED on the disk drive is flashing. The LED is turned off when you have finished creating the volume.
- You can locate individual disk drives from the SAS Topology screen. To do this, move the cursor to the name of the disk in the Device Identifier column and press Enter. The LED on the disk flashes until the next key is pressed.
- You can locate all the disk drives in a volume by selecting the volume on the SAS Topology screen. The LEDs flash on all disk drives in the volume.



NOTE: The LEDs on the disk drives will flash as described above if the firmware is correctly configured and the drives or the disk enclosure supports disk location.

Selecting a Boot Disk

You can select a boot disk in the SAS Topology screen. This disk is then moved to scan ID 0 on the next boot, and remains at this position. This makes it easier to set BIOS boot device options and to keep the boot device constant during device additions and removals. There can be only one boot disk.

Follow these steps to select a boot disk:

1. In the SAS BIOS CU, select an adapter from the ADAPTER LIST.
2. Select the SAS TOPOLOGY option.

The current topology is displayed. If the selection of a boot device is supported, the bottom of the screen lists the ALT+B option. This is the key for toggling the boot device. If a device is currently configured as the boot device, the DEVICE INFO column on the SAS TOPOLOGY screen will show the word **Boot**.

3. To select a boot disk, move the cursor to the disk and press ALT+B.
4. To remove the boot designator, move the cursor down to the current boot disk and press ALT+B. This controller will no longer have a disk designated as boot.
5. To change the boot disk, move the cursor to the new boot disk and press ALT+B. The boot designator will move to this disk.



NOTE: The firmware must be configured correctly in order for the ALT+B feature to work.

Notes

Chapter 8

Integrated Striping

This chapter provides an overview of the LSI Integrated Striping™ (IS) feature and explains how to create Integrated Striping (IS) volumes using the SAS BIOS Configuration Utility (SAS BIOS CU), which is used to setup IR Mode.

8-1 Introduction

The Integrated Striping (IS) feature is used for applications that require the faster performance and increased storage capacity of striping. The low-cost IS feature has many of the advantages of a more expensive RAID striping solution. A single IS logical drive may be configured as the boot disk or as a data disk.

The IS feature is implemented with controller firmware that supports the Fusion-MPT Interface. IS provides better performance and more capacity than individual disks, without burdening the host CPU. The firmware splits host I/Os over multiple disks and presents the disks as a single logical drive. In general, striping is transparent to the BIOS, the drivers, and the operating system.

The SAS BIOS CU is used to configure IS volumes, which can consist of two to ten disks.

8-2 IS Features

Integrated Striping supports the following features:

- Support for volumes with two to ten disks
- Support for two IS volumes (or one IS volume and one IM/IME volume) on a controller, with up to 12 disks total. (Requires Integrated RAID firmware v1.20.00 or above.)



NOTE: All physical disks in a volume must be connected to the same SAS controller.

- Presents a single virtual drive to the OS for each configured volume
- Support for both SAS and SATA drives, although the two types of drives cannot be combined in one volume
- Fusion-MPT architecture
- Easy-to-use SAS BIOS configuration utility
- Error notification
- Use of metadata to store volume configuration on disks
- OS-specific event log
- Error display inside the Fusion-MPT BIOS

- SES status LED support for drives used in IS volumes

8-3 IS Description

The IS feature writes data across multiple disks instead of onto one disk. This is accomplished by partitioning each disk's storage space into 64-KB stripes. These stripes are interleaved round-robin, so that the combined storage space is composed alternately of stripes from each disk.

For example, as shown in Figure 8-1, segment 1 is written to disk 1, segment 2 is written to disk 2, segment 3 is written to disk 3, and so on. When the system reaches the end of the disk list, it continues writing data at the next available segment of disk 1.

Figure 8-1. Integrated Striping Example

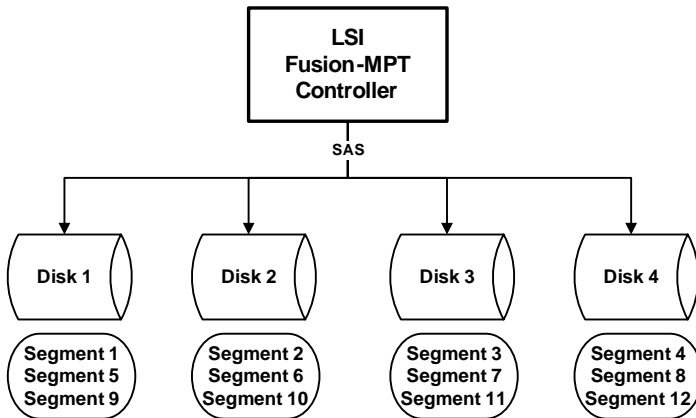
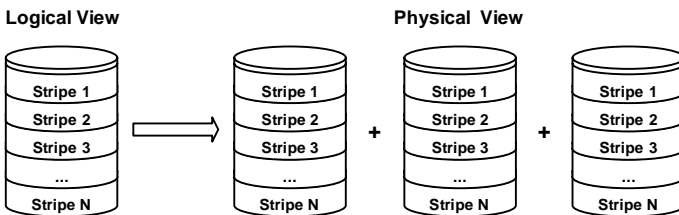

Figure 8-2 shows a logical view and a physical view of Integrated Striping configuration.

Figure 8-2. Integrated Striping – Logical and Physical Views



The primary advantage of IS is speed, because it transfers data to or from multiple disks at once. However, there is no data redundancy; therefore, if one disk fails, that data is lost.

8-4 Integrated Striping Firmware

This section describes features of the Integrated RAID firmware.

Metadata Support

The firmware supports metadata, which describes the IS logical drive configuration stored on each member disk. When the firmware is initialized, each member disk is queried to read the stored metadata to verify the configuration. The usable disk space for each IS member disk is adjusted down when the configuration is created, in order to leave room for this data.

SMART Support

SMART is a technology that monitors hard disk drives for signs of future disk failure and generates an alert if such signs are detected. The firmware polls each physical disk in the volume at regular intervals. If the firmware detects a SMART ASC/ASCQ code on a physical disk in the IS volume, it processes the SMART data and stores it in nonvolatile memory. The IS volume does not support SMART directly, since it is just a logical representation of the physical disks in the volume.

Disk Write Caching

Disk write caching is enabled by default on all IS volumes.

8-5 Fusion-MPT Support

The BIOS uses the LSI Fusion-MPT interface to communicate to the SAS controller and firmware to enable IS. This includes reading the Fusion-MPT configuration to gain access to the parameters that are used to define behavior between the SAS controller and the devices connected to it. The Fusion-MPT drivers for all supported operating systems implement the Fusion-MPT interface to communicate with the controller and firmware.

8-6 IS Configuration Overview

You can use the SAS BIOS CU to create one or two IS volumes, with up to twelve drives total, on an SAS controller. Each volume can have from two to ten drives. Disks in an IS volume must be connected to the same SAS controller, and the controller must be in the BIOS boot order.

Although you can use disks of different size in IS volumes, the smallest disk determines the “logical” size of each disk in the volume. In other words, the excess space of the larger member disk(s) is not used.

Usable disk space for each disk in an IS volume is adjusted down to leave room for metadata. Usable disk space may be further reduced to maximize the ability to interchange disks in the same size classification.

The supported stripe size is 64 kilobytes. Refer to [Section 8-2: "IS Features" on page 8-1](#) for more information about Integrated Striping volumes.

8-7 Creating IS Volumes

The SAS BIOS CU is part of the Fusion-MPT BIOS. When the BIOS loads during boot and you see the message about the Configuration Utility, press Ctrl-C to start it. After you do this, the message changes to:

```
Please wait, invoking SAS Configuration Utility...
```

After a brief pause, the main menu of the SAS BIOS CU appears. On some systems, however, the following message appears next:

```
LSI Configuration Utility will load following initialization!
```

In this case, the SAS BIOS CU will load after the system has completed its power-on self test.

Follow the steps below to configure an Integrated Striping (IS) volume with the SAS BIOS CU. The procedure assumes that the required controller(s) and disks are already installed in the computer system. You can configure an IM/IME volume and an IS volume on the same SAS controller.

Creating IS Volumes

1. On the ADAPTER LIST screen of the SAS BIOS CU, use the arrow keys to select a SAS adapter.
2. Press ENTER to go to the ADAPTER PROPERTIES screen (Figure 8-3).

Figure 8-3. Adapter Properties Screen

```
LSI Corp Config Utility      v6.22.00.00 (2008.04.10)
Adapter Properties -- SAS1068E

Adapter          SAS3442E
PCI Slot         02
PCI Address(Bus/Dev) 00:00
MPT Firmware Revision 1.25.01.00-IR
SAS Address      50030480:00FFFFFF
NUDATA Version   2D.02
Status           Enabled
Boot Order       0
Boot Support     [Enabled BIOS & OS]

RAID Properties

SAS Topology

Advanced Adapter Properties

Esc = Exit Menu      F1/Shift+1 = Help
Enter = Select Item  -/+ /Enter = Change Item
```

3. On the ADAPTER PROPERTIES screen, use the arrow keys to select RAID PROPERTIES and press ENTER.

- When you are prompted to select a volume type, select CREATE IS VOLUME.

The CREATE NEW ARRAY screen (Figure 8-4) that appears shows a list of disks that can be added to a volume.

Figure 8-4. Create New Array Screen

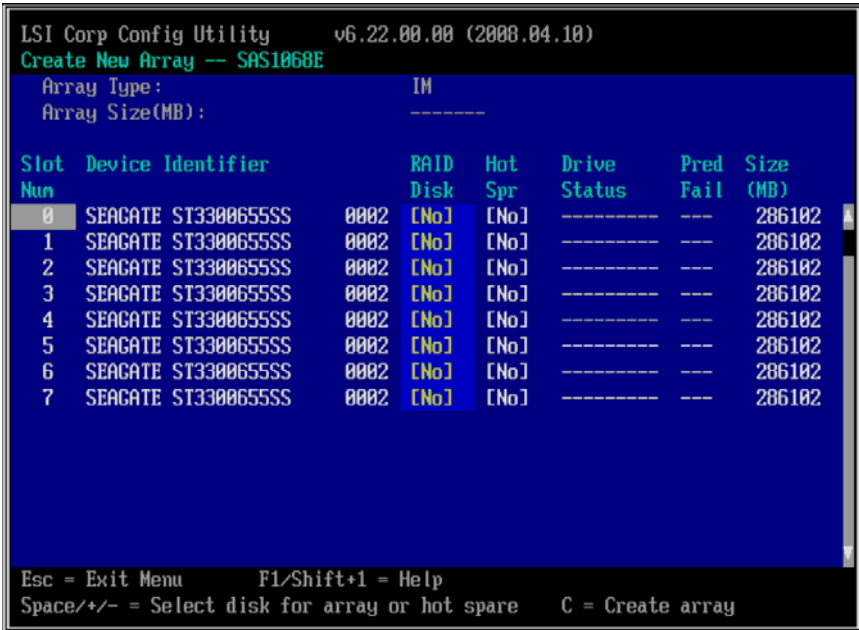

- Move the cursor to the RAID DISK column. To add a disk to the volume, change the No to Yes by pressing the + key, - key, or SPACE bar.

As disks are added, the ARRAY SIZE field changes to reflect the size of the new volume.

- When you have added the desired number of disks to the array, press **C** and then select SAVE CHANGES. Then exit this menu to commit the changes.

The configuration utility pauses while the array is being created.

Be aware that there are several limitations when creating an IS (RAID 0) volume:

- All disks must be either SATA (with extended command set support) or SAS (with SMART support).
- Disks must have 512-byte blocks and must not have removable media.
- There must be at least two and no more than ten drives in a valid IS volume. Hot spare drives are not allowed.

8-8 Creating a Second IS Volume

SAS controllers allow you to configure two IS volumes, or an IS volume and an IM/IME volume. If one volume is already configured, and if there are available disk drives, there are two ways to add a second volume.

The first way to add a second volume is as follows:

1. In the configuration utility, select an adapter from the ADAPTER LIST screen and then select the RAID PROPERTIES option.

This displays the current volume.

2. Press **C** to create a new volume.
3. Continue with [step 4 of Section 8-7: "Creating IS Volumes" on page 8-4](#) to create a second IS volume.

The other way in which to add a second volume is as follows:

1. On the ADAPTER LIST screen, use the arrow keys to select an SAS adapter.
2. Press ENTER to go to the ADAPTER PROPERTIES screen ([Figure 8-3](#)).
3. On the ADAPTER PROPERTIES screen, use the arrow keys to select RAID PROPERTIES and press ENTER.
4. Continue with [step 4 of Section 8-7: "Creating IS Volumes" on page 8-4](#) to create a second IS volume.

8-9 Other Configuration Tasks

This section explains how to perform other configuration and maintenance tasks for IS volumes.

Viewing IS Volume Properties

Follow these steps to view the properties of IS volumes:

1. In the configuration utility, select an adapter from the ADAPTER LIST screen. Select the RAID PROPERTIES option.

The properties of the current volume are displayed.

2. If more than one volume is configured, press ALT+N to view the next array.
3. To manage the current array, press ENTER when the MANAGE ARRAY item is selected.

Activating an Array

An array can become inactive if, for example, it is removed from one controller or computer and moved to another one. The ACTIVATE ARRAY option allows you to reactivate an inactive array that has been added to a system. This option is only available when the selected array is currently inactive.

Follow these steps to activate a selected array.

1. Select **ACTIVATE ARRAY** on the **MANAGE ARRAY** screen.
2. Press **Y** to proceed with the activation, or press **N** to abandon it.

After a pause, the array will become active.

Deleting an Array



WARNING: Before deleting an array, be sure to back up all data on the array that you want to keep.

Follow these steps to delete a selected array:

1. Select **DELETE ARRAY** on the **MANAGE ARRAY** screen.
2. Press **Y** to delete the array, or press **N** to abandon the deletion.

After a pause, the firmware deletes the array.



NOTE: Once a volume has been deleted, it cannot be recovered. The master boot records of all disks are deleted.

Locating a Disk in a Volume

You can use the SAS BIOS CU to locate and identify a specific physical disk drive by flashing the drive's LED. You can also use the SAS BIOS CU to flash the LEDs of all the disk drives in a RAID volume. There are several ways to do this:

- When you are creating an IS volume, and a disk drive is set to **Yes** as part of the volume, the LED on the disk drive is flashing. The LED is turned off when you have finished creating the volume.
- You can locate individual disk drives from the **SAS TOPOLOGY** screen. To do this, move the cursor to the name of the disk in the **DEVICE IDENTIFIER** column and press **ENTER**. The LED on the disk flashes until the next key is pressed.
- You can locate all the disk drives in a volume by selecting the volume on the **SAS TOPOLOGY** screen. The LEDs flash on all disk drives in the volume.



NOTE: The LEDs on the disk drives will flash as described above if the firmware is correctly configured and the drives or the disk enclosure supports disk location.

Selecting a Boot Disk

You can select a boot disk in the SAS TOPOLOGY screen. This disk is then moved to scan **ID 0** on the next boot, and remains at this position. This makes it easier to set BIOS boot device options and to keep the boot device constant during device additions and removals. There can be only one boot disk.

Follow these steps to select a boot disk:

1. In the SAS BIOS CU, select an adapter from the ADAPTER LIST.
2. Select the SAS TOPOLOGY option.

The current topology is displayed. If the selection of a boot device is supported, the bottom of the screen lists the ALT+B option. This is the key for toggling the boot device. If a device is currently configured as the boot device, the DEVICE INFO column on the SAS TOPOLOGY screen will show the word **Boot**.

3. To select a boot disk, move the cursor to the disk and press ALT+B.
4. To remove the boot designator, move the cursor down to the current boot disk and press ALT+B. This controller will no longer have a disk designated as boot.
5. To change the boot disk, move the cursor to the new boot disk and press ALT+B. The boot designator will move to this disk.



NOTE: The firmware must be configured correctly in order for the ALT+B feature to work.

Notes

Chapter 9

Using the CFGGEN IR Configuration Utility

This Chapter describes how to use the CFGGEN IR Configuration Utility to create Integrated Mirroring (IM), Integrated Mirroring Enhanced (IME), and Integrated Striping (IS) volumes on SAS controllers. CFGGEN is a command line utility that runs in the DOS, Linux, EFI, and Windows Pre-Installation (WinPE) environments. CFGGEN is a minimally interactive program that can be executed from a command line prompt or a shell script.



NOTE: CFGGEN is intended for use *only in the manufacturing environment*. End users can use the BIOS-based configuration utility to create IM, IME, and IS volumes. (See [Section 7-7: "Creating IM and IME Volumes" on page 7-6](#) and [Section 8-7: "Creating IS Volumes" on page 8-4](#))

9-1 Hardware and Software Requirements

The CFGGEN IR Configuration Utility runs on any Intel IA-32 or IA64 compatible platform. It works with storage devices that are compliant with existing SCSI standards. CFGGEN supports the LSI SAS1064/1064E, LSI SAS1068/1068E, and LSI SAS1078 LSI SAS controller chips.

CFGGEN runs in the following operating environments:

- **DOS** – CFGGEN runs in any environment that is fully DOS compatible and has at least 640-KB of memory. The system BIOS must support 32-bit BIOS services, including the PCI BIOS services. CFGGEN uses these services to locate the controller and its interface registers. CFGGEN must be able to directly access the controller chip's interface registers.



NOTE: You cannot run CFGGEN in a virtual DOS window from within Windows.

- **EFI** – CFGGEN runs in any environment that is fully EFI compatible.
- **Linux** – CFGGEN is a statically linked Linux application. Static linking prevents any library version compatibility problems that might stop CFGGEN from working with a specific release or distribution of Linux. Version 3.02.04 or newer of the LSI *mptlinux* driver must be installed on the system. The required modules include *mptbase.o*, *mptscsih.o*, and *mptctl.o*.



WARNING: The modules `mptbase.o`, `mptscsih.o` and `mptctl.o` must be loaded into the Linux kernel before CFGGEN will function correctly. They can be loaded using the Linux `modprobe` command.

- **WinPE** – CFGGEN runs in Windows Pre-Installation Environment (WinPE) and is statically compiled with the LSI *MptLib* Library (*MptLib.lib*). The WinPE environment must have the appropriate LSI MPT Windows driver (*Miniport* or *Storport*) installed and loaded in order to recognize and communicate with the I/O controller.

9-2 CFGGEN Interface Description

CFGGEN uses a command line interface. Commands are formatted as follows:

```
cfggen <controller #> <command> <parameters>
```

The program name, controller number, command, and parameters fields must be separated by the ASCII space character. The parameter format is command specific, as described in "[CFGGEN Commands](#)" below.

Information is passed between the user environment and CFGGEN via the command line, the standard output and standard error interfaces, and the program return value. The user can redirect the output streams. The return value is generated when the program exits. A value of 0 is returned if the command is successful. Otherwise, a value of 1 is returned.

9-3 CFGGEN Commands

CFGGEN has the following commands:

- CREATE
- DEFAULTS (called DELETE in the EFI version)
- DISPLAY
- FORMAT
- HOTSPARE
- STATUS
- SETOFFLINE (DOS, Linux, and WinPE versions only)
- SETONLINE (DOS, Linux, and WinPE versions only)
- AUTO (EFI version only)
- DISABLEIR (EFI version only)
- ENABLEIR (EFI version only)
- LIST (EFI version only)

CFGGEN is not case sensitive. You can type CFGGEN commands and parameters in uppercase, lowercase, or a mixture of the two.

The following conventions are used in the command descriptions:

- Text in *italics* must be entered exactly as shown on the command line.

- Text surrounded by <> must be replaced with a required parameter.
- Text surrounded by [] may be replaced by an optional parameter.
- Parameters surrounded by {} must be entered one or more times, as is appropriate for the command being executed.
- The command line definition characters <>, [], and {} must not be entered on the command line.

Common Command Line Parameters

This section describes CFGGEN command line parameters that are common to more than one command.

- **<controller #>** – The unique controller number of a PCI function found in the system, starting with controller # 0. For example, in a system containing two SAS1068 controllers, controller # 0 references the first controller and controller # 1 references the other controller.

Valid controller number values are 0 to 255 (decimal).

- **<SCSI ID>** – The SCSI bus address of a peripheral device attached to an SAS controller. The valid SCSI ID values for supported SAS controllers are 0 to 127 (decimal) per controller.



NOTE: With PBSRAM, the SAS1068/1068E controllers can support more than 128 devices.

- **<Enclosure:Bay>** – The Enclosure and bay/slot of a peripheral device attached to the bus. The argument must use a colon (:) as a separator and must follow the enclosure:bay format. This argument is only valid when used with the bay command line argument. Valid numbers are 0 to 127 (decimal).

CREATE Command

The CREATE command creates IM, IME, and IS volumes on supported SAS controllers.

When a disk drive is added to an IM, IME, or IS volume, its entire storage capacity may or may not be used, depending on drive capacity and volume capacity. For example, if you add a 36-GB disk drive to a volume that only uses 9-GB of capacity on each disk drive, the remaining 27-GB of capacity on the disk drive is unusable.

The disk identified by the first SCSI ID on the command line is assigned as the primary disk drive when an IM volume is created. If the controller is allowed to resync the disk drives, the data on the primary disk drive will be available when you access the newly created volume.

The following rules must be observed when creating IM, IME, and IS volumes and hot spare disks:

1. All disks that are part of a volume, including global hot spares, must be on the same SAS controller.
2. A maximum of two IM, IME, or IS volumes per controller can be created.
3. The total number of disks in a volume cannot exceed ten, and the total number of disks combined for two volumes cannot exceed twelve. In addition, one or two hot spare disks can be created per controller to support IM and IME volumes, for a maximum of 14 supported disks per SAS controller. (Support for this number of disks requires Integrated RAID firmware v1.20.00 or above.)
4. An IM volume must have exactly two disks.
5. An IME volume can have a minimum of three disks and a maximum of ten disks, as long as rule 3 is not violated.

Command Line –

```
cfggen <controller #> create <volume type> <size>
{<SCSI ID>} [qsync] [noprompt]
cfggen <controller #> create <volume type> <size> bay
{<enclosure:bay>} [qsync] [noprompt]
```

Parameters –

- <controller #> – Number of the SAS controller targeted by this command.
- <volume type> – Volume type for the new volume to be created. Valid values are IM or IME or IS.
- <size> – Size of the RAID volume in megabytes, or MAX for the maximum size available.
- Bay – This option indicates that enclosure:bay values are specified instead of SCSI ID values.
- <SCSI ID> – SCSI ID of a hard disk drive to be included in the RAID volume.
- <enclosure:bay> – The enclosure:bay value for the disk drive to be included in the RAID volume. These values can be obtained from the output of the DISPLAY command.
- qsync – If this optional parameter is specified, a quick synchronization of new volume will be performed. If the volume type is IME or IS, a quick synchronization is always performed even if qsync is not specified. A quick synchronization means that the first 32-KB of the drives in the volume are cleared to 0.
- noprompt – Suppresses display of warnings and prompts.

Program Return Value –

0x00 SUCCESS: command completed successfully.

0x01 FAILURE: bad command line arguments or operational failure.

DEFAULTS Command



NOTE: This command is called DELETE in the EFI version of CFGGEN.

The DEFAULTS (DELETE) command deletes any IM, IME, and IS volumes and hot spare drives created by the CREATE and HOTSPARE commands. No other controller configuration parameters are changed.

Command Line –

DOS, Linux, WinPE versions:

```
cfggen <controller #> defaults [noprompt]
```

EFI version:

```
cfggen <controller #> delete [noprompt]
```

Parameters –

- `<controller #>` – Number of the SAS controller targeted by this command.
- `noprompt` – Suppresses display of warnings and prompts.

Program Return Value –

0x00 SUCCESS: command completed successfully.

0x01 FAILURE: bad command line arguments or operational failure.

DISPLAY Command

The DISPLAY command displays configuration information for the supported SAS controllers. The information includes controller type, firmware version, BIOS version, volume information, and physical drive information. An example of the information that will be output by this command is provided in Sample Output below.



NOTE: 1 megabyte = 1,048,576 bytes. All sizes displayed in megabytes are rounded down to the nearest megabyte.

Command Line –

```
cfggen <controller #> display [filename]
```

Parameters –

- `<controller #>` – Number of the SAS controller targeted by this command.
- `[filename]` – Optional valid filename to store the output of the command to a file.

Program Return Value –

0x00 SUCCESS: command completed successfully.
0x01 FAILURE: bad command line arguments or operational failure.

Sample Output –

The following example shows a sample output of the CREATE command when used to create an IM configuration.

```
Read configuration has been initiated for controller 0
-----
Controller information
-----
Controller type           : LSI1064/1068
BIOS version              : 6.05.05.00
Firmware version         : 0.07.01.00
SCSI channel description : 1 Serial Attached SCSI
Initiator IDs (SCSI ID)  : 63
Maximum physical devices : 62
Concurrent commands supported : 511
Slot                      : 1
Bus                       : 2
Device                   : 2
Function                  : 0
-----
IR Volume information
-----
IR volume 1
Status of volume          : Okay (OKY)
RAID level                : 1
Size (in MB)              : 34332
Physical hard disks (SCSI ID) : 10 7
-----
Enclosure information
-----
Enclosure #              : 1
Enclosure WWN            : 12345678:ABCDABCD
Start Slot                : 1
Num Slots                 : 4
Start SCSI ID             : 0
-----
Physical device information
-----
Initiator at SCSI ID 63
Target on SCSI ID 7
Enclosure #              : 1
Slot #                   : 1
Device is a Hard disk
SCSI ID                   : 7
State                     : Online (ONL)
Size (in MB)/(in sectors) : 34732/71132958
```



```
Manufacturer           : MAXTOR
Model Number           : ATLAS15K2_036SAS
Firmware Revision      : BG31
Serial No              : E204EY1K
Drive Type             : SAS
Target on SCSI ID 8
Enclosure #           : 1
Slot #                 : 2
Device is a Hard disk
SCSI ID                : 8
State                  : Hot Spare (HSP)
Size (in MB)/(in sectors) : 35074/71833095
Manufacturer           : MAXTOR
Model Number           : ATLAS15K2_36SAS
Firmware Revision      : BG34
Serial No              : E207AY6K
Drive Type             : SAS
Target on SCSI ID 9
Enclosure #           : 1
Slot #                 : 3
Device is a Hard disk
SCSI ID                : 9
State                  : Ready (RDY)
Size (in MB)/(in sectors) : 34732/71132959
Manufacturer           : MAXTOR
Model Number           : ATLAS15K2_036SAS
Firmware Revision      : BG31
Serial No              : E204ERCK
Drive Type             : SAS
Target on SCSI ID 10
Enclosure #           : 1
Slot #                 : 4
Device is a Hard disk
SCSI ID                : 10
State                  : Online (ONL)
Size (in MB)/(in sectors) : 140299/287332383
Manufacturer           : MAXTOR
Model Number           : ATLAS15K2_147SAS
Firmware Revision      : BG34
Serial No              : E803YMCK
Drive Type             : SAS
```

Logical drive status values are as follows:

- Okay (OKY) – Volume is Active and drives are functioning properly. User data is protected if the volume is IM or IME.
- Degraded (DGD) – Volume is Active. User data is not fully protected due to a configuration change or drive failure.
- Rebuilding (RBLD) – Data resync or rebuild may be in progress.

- **Inactive, Okay (OKY)** – Volume is inactive and drives are functioning properly. User data is protected if the current RAID level is RAID 1 (IM) or RAID 1E (IME).
- **Inactive, Degraded (DGD)** – Volume is inactive and the user's data is not fully protected due to a configuration change or drive failure; a data resync or rebuild may be in progress.

Physical drive status values are as follows:

- **Online (ONL)** – Drive is operational and is part of a logical drive.
- **Hot Spare (HSP)** – Drive is a hot spare that is available to replace a failed drive in an array.
- **Ready (RDY)** – Drive is ready for use as a normal disk drive; or it is available to be assigned to a disk array or used as a hot spare.
- **Available (AVL)** – Drive may or may not be ready, and it is not suitable for use in an array or as a hot spare. Possible reasons for this are: it is not spun up, its block size is incorrect, or its media is removable.
- **Failed (FLD)** – Drive was part of a logical drive or was a hot spare drive, and it failed. It has been taken offline.
- **Standby (SBY)** – This status is used to tag all non-hard disk drive devices.

FORMAT Command

The FORMAT command is used to perform a low-level format of a disk drive. The drive cannot be a hot spare drive or a member of an IM, IME, or IS volume.



WARNING: A low-level format erases all data on the hard disk drive. The FORMAT command cannot and should not be interrupted; doing so may result in irreparable damage to the hard disk drive.

Warning messages are displayed during the formatting, unless the *noprompt* option is included on the command line. If the user does not quickly respond to a series of prompts, the command is aborted. The answers are case sensitive and must be entered in upper case.

The FORMAT command does not complete and return to a shell prompt until the format operation is complete. This may take a long time for a large disk drive.

Command Line –

```
cfggen <controller #> format <SCSI ID> [noprompt]
cfggen <controller #> format bay <enclosure:bay> [noprompt]
```

Parameters –

- **<controller #>** – Number of the controller targeted by this command.
- **Bay** – This option indicates that enclosure:bay values are specified instead of SCSI ID values.
- **<SCSI ID>** – SCSI ID of the hard disk drive to be formatted.
- **<enclosure:bay>** – The enclosure:bay value for the disk drive to be formatted. These values can be obtained from the output of the DISPLAY command.

- `noprompt` – Suppresses display of warnings and prompts.

Program Return Value –

0x00 SUCCESS: command completed successfully.

0x01 FAILURE: command failed.

HOTSPARE Command

The HOTSPARE command creates a hot spare disk drive. One or two hot spare disk can be created per controller. The capacity of a hot spare disk must be greater than or equal to the capacity of the smallest disk in the logical drive. An easy way to verify this is to use the DISPLAY command.

The following rules must be observed when creating hot spare disks:

1. A hot spare disk cannot be created unless at least one IM or IME volume is already created.
2. CFGGEN does not allow adding a hot spare disk of a type (SAS/SATA) that is different from the disk types in any of the volumes.

Command Line –

```
cfggen <controller #> hotspare <SCSI ID>
cfggen <controller #> hotspare bay <enclosure:bay>
```

Parameters –

- `<controller #>` – Number of the SAS controller targeted by this command.
- `Bay` – This option indicates that enclosure:bay values are specified instead of SCSI ID values.
- `<SCSI ID>` – SCSI ID of the drive targeted by this command.
- `<enclosure:bay>` – The enclosure:bay value for the disk drive to use for the new hot spare disk. These values can be obtained via the output of the DISPLAY command.

Program Return Value –

0x00 SUCCESS: command completed successfully.

0x01 FAILURE: bad command line arguments or operational failure.

STATUS Command

The STATUS command displays the status of any volume synchronization operation that is currently in progress on the controller. If no such operation is in progress, CFGGEN displays a message indicating this before it exits. The STATUS command adds the flag Inactive to the Volume State field, if the controller firmware marks the volume as Inactive.

Command Line –

```
cfggen <controller #> status
```

Parameters –

- <controller #> – Number of the SAS controller targeted by this command.

Program Return Value –

0x00 SUCCESS: command completed successfully.
0x01 FAILURE: command failed.

Sample Output –

Here is an example of the status information returned when a volume resynchronization is in progress:

```
Background command progress status for controller 0...
IR Volume 1
Current operation           : Synchronize
Volume ID                  : 6
Volume status              : Enabled
Volume state               : Degraded
Physical disk I/Os        : Not quiesced
Volume size (in sectors)   : 70311936
Number of remaining sectors : 68250624
Percentage complete       : 2.93%
```

Here is an example of the status information returned when no background volume operation is in progress:

```
Background command progress status for controller 0...
IR Volume 1
Current operation           : None
Volume ID                  : 6
Volume status              : Enabled
Volume state               : Optimal
Physical disk I/Os        : Not quiesced
```

The status fields in the data displayed can have the following values:

- Current operation – *Synchronize* or *None*
- Volume status – *Enabled* or *Disabled*
- Volume state – *[Inactive] Optimal, Degraded, or Failed*
- Physical disk I/Os – *Quiesced* or *Not quiesced*

SETOFFLINE Command



NOTE: The SETOFFLINE command is supported by the DOS, Linux, and WinPE versions of CFGGEN only.

The SETOFFLINE command makes a physical disk in a volume offline. A physical disk that is taken offline changes its state to Failed (FLD), but the disk is still associated with the volume and therefore cannot be addressed by normal I/O requests. If a new disk replaces an offline disk, the new disk is automatically brought online. Otherwise, the disk remains offline until explicitly brought online by SETONLINE command.

Command Line –

```
cfggen <controller #> setoffline <SCSI ID>
```

Parameters –

- <controller #> – Number of the SAS controller targeted by this command.
- <SCSI ID> – SCSI target ID of the drive targeted by this command.

Program Return Value –

0x00 SUCCESS: command completed successfully.

0x01 FAILURE: command failed.

SETONLINE Command



NOTE: The SETONLINE command is supported by the DOS, Linux, and WinPE versions of CFGGEN only.

The SETONLINE command brings a physical disk in a volume online. This is required only after the physical disk has been taken offline by the SETOFFLINE command. When a physical disk is brought online, the IOC synchronizes the volume.

Command Line –

```
cfggen <controller #> setonline <SCSI ID>
```

Parameters –

- <controller #> – Number of the controller targeted by this command.
- <SCSI ID> – SCSI target ID of the drive targeted by this command.

Program Return Value –

0x00 SUCCESS: command completed successfully.

0x01 FAILURE: command failed

AUTO Command (EFI Version Only)

The AUTO command, which is currently supported only in the EFI version of CFGGEN, automatically creates an IM, IME, or IS volume. The volume is created with the maximum number of disks available for use in the specified volume type. The main difference from the CREATE command is that with the AUTO command you do not specify SCSI ID values for disks to use in the volume. CFGGEN automatically creates the volume with the first usable disks it finds. Firmware and hardware limitations for the family of controllers limit the number of configurations that are possible.

When a disk drive is added to an IM, IME, or IS volume, its entire storage capacity may or may not be used, depending on drive capacity and volume capacity. For example, if you add a 36-GB disk drive to a volume that only uses 9-GB of capacity on each disk drive, the remaining 27-GB of capacity on the disk drive are unusable.

When AUTO creates an IM volume, the first disk found is assigned as the primary disk drive. If the controller is allowed to resync the disk drives, the data on the primary disk drive will be available by accessing the newly created volume.

CFGGEN follows these rules when creating IM, IME, and IS volumes and hot spare disks with the AUTO command:

1. All disks that are part of a volume and the hot spares for a volume must be connected to the same controller.
2. IM, IME, and IS volumes are supported.
3. One or two volumes can be created on a single SAS controller.
4. SAS and SATA drives cannot be mixed in a volume. With the AUTO command, all drives used must be the same type as the first available disk found.
5. An IM volume must have exactly two disks.
6. An IME volume can have three to ten disks, as long as rules 4 and 5 are not violated. An IS volume can have two to ten disks.
7. The total number of disks combined for two volumes cannot exceed twelve. In addition, one or two hot spare disks can be created per controller, making a maximum of 14 disks supported per controller. (Support for this number of disks requires Integrated RAID firmware v1.20.00 or above.)

Command Line –

```
cfggen <controller #> auto <volume type> <size>  
[qsync] [noprompt]
```

Parameters –

- `<controller #>` – Number of the SAS controller targeted by this command.
- `<volume type>` – Volume type for the volume to be created. Valid values are IM, IME, and IS.
- `<size>` – Size of the RAID volume in megabytes, or MAX for the maximum size available.
- `[qsync]` – If this optional parameter is specified, a quick synchronization of new volume will be performed. If the volume type is IME or IS, a quick synchronization is always performed even if this option is not specified. A quick synchronization means that the first 32-KB of the drives in the volume are cleared to 0.
- `noprompt` – Suppresses display of warnings and prompts.

Program Return Value –

0x00 SUCCESS: command completed successfully.

0x01 FAILURE: bad command line arguments or operational failure.

DISABLEIR Command (EFI Version Only)

The DISABLEIR command, which is currently supported only in the EFI version of CFGGEN, disables Integrated RAID functionality on the supported SAS controller chips. This is done by setting the MPI_IOUNITPAGE1_DISABLE_IR bit in the IO Unit 1 MPT Configuration Page.

If there are any existing IM, IME, or IS volumes when this command is run, the user is notified via an output message, no action is taken, and CFGGEN returns FAILURE. If Integrated RAID is already disabled when this command is run, CFGGEN returns SUCCESS.

Command Line –

```
cfggen <controller #> disableir
```

Parameters –

- <controller #> – Number of the SAS controller targeted by this command.

Program Return Value –

0x00 SUCCESS: command completed successfully.

0x01 FAILURE: bad command line arguments or operational failure.

ENABLEIR Command (EFI Version Only)

The ENABLEIR command, which is currently supported only in the EFI version of CFGGEN, enables Integrated RAID functionality on the supported SAS controller chips. This is done by clearing the MPI_IOUNITPAGE1_DISABLE_IR bit in the IO Unit 1 MPT Configuration Page.

If there are any existing IM, IME, or IS volumes when this command is run, the user is notified via an output message, no action is taken, and CFGGEN returns SUCCESS. If Integrated RAID is already enabled when this command is run, CFGGEN returns SUCCESS.

Command Line –

```
cfggen <controller #> enableir
```

Parameters –

- <controller #> – Number of the SAS controller targeted by this command.

Program Return Value –

0x00 SUCCESS: command completed successfully.

0x01 FAILURE: bad command line arguments or operational failure.

LIST Command (EFI Version Only)

The LIST command, which is currently supported only in the EFI version of CFGGEN, displays a list of all controllers present in the system, along with their corresponding controller #.

Command Line –

```
cfggen list
```

Parameters –

None

Program Return Value –

0x00 SUCCESS: command completed successfully.

0x01 FAILURE: bad command line arguments or operational failure.

Disclaimer

The products sold by Supermicro are not intended for and will not be used in life support systems, medical equipment, nuclear facilities or systems, aircraft, aircraft devices, aircraft/emergency communication devices or other critical systems whose failure to perform be reasonably expected to result in significant injury or loss of life or catastrophic property damage. Accordingly, Supermicro disclaims any and all liability, and should buyer use or sell such products for use in such ultra-hazardous applications, it does so entirely at its own risk. Furthermore, buyer agrees to fully indemnify, defend and hold Supermicro harmless for and against any and all claims, demands, actions, litigation, and proceedings of any kind arising out of or related to such ultra-hazardous use or sale.

